

DURA[®]



600 SERIES

Product catalogue

Catalogue de produits

Produktkatalog







Catalogo dei prodotti

Catálogo de productos

Productcatalogus

Issue 25A

DURA®

-  Dura originated the concept of integrated workshops in 1997 and remains the leader in this sector. Design is at the forefront of what we do – our philosophy is to listen to our customers and provide them with the products of the highest quality, designed and delivered with unmatched levels of service.
-  C'est en 1997 que Dura a lancé le concept des ateliers intégrés. A ce jour, il demeure le chef de file de ce secteur. Le travail de conception est au coeur même de notre métier et nous sommes à l'écoute permanente de nos clients afin de leur proposer des produits de haute qualité, conçus et fournis grâce à un service clientèle insurpassé.
-  Dura entwickelte 1997 erstmals das Konzept der integrierten Werkstatt und ist auch heute noch auf diesem Sektor marktführend. Designkonzepte sind unser wichtigstes Anliegen – unsere Philosophie verlangt von uns, genau auf die Wünsche des Kunden zu hören und ihm Produkte von höchster Qualität zu bieten, geliefert und entwickelt mit bisher unerreichtem Serviceniveau.
-  A partire dal 1997 Dura si è dotata di officine integrate e ancora oggi rimane il leader in questo settore. Nella nostra attività l'attenzione al design è prioritaria e la nostra filosofia consiste nell'ascoltare i bisogni dei clienti e offrire loro prodotti di altissima qualità, progettati e forniti con un livello di servizio ineguagliato.
-  Dura introdujo el concepto de talleres integrales en 1997 y sigue siendo líder del sector. El diseño juega un papel primordial en todo lo que hacemos – nuestra filosofía es escuchar a los clientes y ofrecerles productos de la máxima calidad, diseñados y despachados con unos niveles de servicio inigualables.
-  Dura heeft in 1997 het concept van een geïntegreerde werkplaats ontworpen en is nog altijd leider in deze sector. Het ontwerp vormt de basis van wat wij doen – onze filosofie is om naar onze klanten te luisteren en hen te voorzien van producten van de hoogste kwaliteit, ontworpen en geleverd met een ongeëvenaarde niveaus van service.





600 series

Tool Storage Cabinets	Meubles de rangement pour outils	Werkzeugschränke	7
Mobile Workstations	Postes de travail mobiles	Mobile Arbeitsplätze	29
Under-bench Tool Storage Cabinets	Meubles de rangement des outils sous l'établi et les unités de pontage	Werkzeugschränke unter der Werkbank und Verbindungseinheiten	35
Vertical Special Service Tool Cabinets	Rangements verticaux spéciaux pour outils lourds	Vertikale Schränke für spezielle Servicewerkzeuge	43
Integrated Fluid Management	Gestion des fluides intégrée	Integriertes Flüssigkeitsmanagement	47
General Storage Cabinets	Placards de rangement basique	Allgemeine Lagerschränke	55
Specialised Base Cabinets	Placards de rangements spécialisés	Spezielle Unterschränke	77
Wall Cabinets and Under-Cabinet Lighting	Armoires murales et éclairage sous l'armoire	Wandschränke und Unterschrank-beleuchtungen	95
Back Panels and Fittings	Panneaux arrières et fixations	Rückpaneele und Anschlüsse	111
Workbenches and Trolleys	Postes de travail et chariots	Werkbänke und Transportwagen	125
Accessories	Accessoires	Zubehör	137
ServicePod™			
ServicePod™	ServicePod™	ServicePod™	153
Wall Cladding & Modular Partition Wall Systems			
Wall Cladding & Modular Partition Wall Systems	Système de revêtement mural & Système mural modulaire	Wandverkleidungssystem & Modulares Wandsystem	163
Other			
Bespoke Product Service	Service de conception d'articles sur mesure	Maßgeschneiderter Produktdesignservice	169
Product Index	Index de produit	Produktverzeichnis	173



600 series

Armadi per lo stoccaggio degli utensili	Armarios de almacenamiento de herramientas	Opbergkasten voor gereedschap	7
Banchi di lavoro mobili	Puestos de trabajo móviles	Mobiele Werkstations	29
Armadi per lo stoccaggio degli utensili da posizionare sotto scrivanie e unità di collegamento	Armarios de almacenamiento de herramientas bajo el banco y unidades de unión	Opbergkasten voor gereedschap onder werkbank en overbruggingsstukken	35
Armadi per attrezzi speciali verticali	Armarios verticales para herramientas de servicio especiales	Verticale kasten voor speciaal gereedschap	43
Gestione integrata dei fluidi	Gestión de fluido integrada	Geïntegreerd vloeistofbeheer	47
Armadi bassi per lo stoccaggio generale	Armarios de base para almacenamiento general	Algemene onderkasten	55
Armadi bassi per lo stoccaggio specializzato	Armarios de base para almacenamiento especializado	Speciale onderkasten	77
Armadi a muro e illuminazione inferiore	Armarios de muro y alumbrado bajo los armarios	Wandkasten en verlichting onder kasten	95
Pannelli posteriori e attrezzature	Paneles traseros y fijaciones	Achterpanelen en bekleding	111
Banchi di lavoro e carrelli	Bancos de trabajo y carros	Werkbanken en rolwagens	125
Accessori	Accesorios	Accessoires	137
ServicePod™			
ServicePod™	ServicePod™	ServicePod™	153
Wall Cladding & Modular Partition Wall Systems			
Rivestimenti a parete & Sistema a muro modulare	Sistema de revestimiento mural & Sistema de muro modular	Wandbekledingssysteem & Modulair wandsysteem	163
Other			
Servizio di progettazione di prodotti su misura	Servicio personalizado de diseño de producto	Product Design Service op Maat	169
Indice dei prodotti	Índice de productos	Index van producten	173

Tool Storage Cabinets

Meubles de rangement pour outils

Werkzeugschränke

Armadi per lo stoccaggio degli utensili

Armarios de almacenamiento de herramientas

Opbergkasten voor gereedschap



Tool Storage Cabinets

Product features include:

- A** Heavy-duty epoxy coated 1.2mm steel construction
- B** Hard-wearing composite worksurface
- C** Fully lockable cabinet
- D** Handle for mobile units
- E** Anti-tilt mechanism for mobile units
- F** Drawers available in three depths with handle slots for labels
- G** Lockable castors or adjustable feet
- H** Foam inlay for drawers as standard
- I** Medium drawer with inner sliding tray (RCD)

Meubles de rangement pour outils

Les caractéristiques du produit comprennent:

- A** Fabriqué en acier de 1.2mm recouvert d'une couche de résine époxydique hautement résistante
- B** Surface de travail en composite résistant à l'usure
- C** Meuble de rangement entièrement verrouillable
- D** Poignée pour les unités mobiles
- E** Mécanisme anti-basculement pour les unités mobiles
- F** Tiroirs disponibles en 3 profondeurs avec des emplacements pour étiquettes dans la poignée
- G** Roulettes avec blocage intégré ou pieds ajustables
- H** Incrustation de mousse de série pour les tiroirs
- I** Tiroir de taille moyenne avec plateau coulissant intérieur (RCD)

Werkzeugschränke

Die Produkteigenschaften umfassen:

- A** Mit Epoxydharz ummantelte 1.2mm Stahlkonstruktion für hohe Beanspruchungen
- B** Verschleißfeste Arbeitsoberfläche aus Verbundwerkstoff
- C** Völlig verschließbarer Schrank
- D** Griff für bewegliche Einheiten
- E** Antikipp-Mechanismus für bewegliche Einheiten
- F** Schubladen mit Einschubschlitzen in den Griffen für Etiketten. In 3 Tiefen erhältlich
- G** Blockierbare Rollen oder regelbare Füße
- H** Schaumstoffeinlage für Schubladen standardmäßig
- I** Mittlere Schublade mit Innenschubfach (RCD)

Armadi per lo stoccaggio degli utensili

Le caratteristiche del prodotto comprendono:

- A** Struttura di acciaio di 1.2mm rivestita di resine epossidiche resistenti
- B** Superficie di lavoro di composto inalterabile
- C** Armadio completamente chiudibile a chiave
- D** Maniglia per unità mobili
- E** Meccanismo anti-ribaltamento per unità mobili
- F** Cassetti disponibili in 3 profondità con maniglie con possibilità di inserire etichette
- G** Ruote orientabili bloccabili o piedini regolabili
- H** Gommapiuma per cassetto in dotazione
- I** Cassetto medio con ripiano interno scorrevole (RCD)

Armarios de almacenamiento de herramientas

El producto tiene las características siguientes:

- A** Fabricación robusta de acero de 1.2mm con revestimiento de epoxi
- B** Superficie de trabajo compuesta resistente
- C** Armario totalmente cerrado con llave
- D** Soporte para las unidades móviles
- E** Mecanismo antibasculamiento para unidades móviles
- F** Cajones disponibles en 3 profundidades con ranuras en las manijas para las etiquetas
- G** Ruedas giratorias bloqueables o patas ajustables
- H** Revestimiento de espuma para los cajones en estándar
- I** Cajón medio con bandeja deslizante interior (RCD)

Opbergkasten voor gereedschap

Technische kenmerken:

- A** Zware stalen constructie 1.2mm met epoxy coating
- B** Onaantastbaar composiet werkoppervlak
- C** Volledig afsluitbare kast
- D** Hendel voor verplaatsbare units
- E** Anti-kantel mechanisme voor verplaatsbare units
- F** Laden leverbaar in 3 verschillende dieptes met gleuven voor labels
- G** Vergrendelbare wielen of verstelbare poten
- H** Standaard schuim inleg voor laden
- I** Middelgrote lade met ingebouwd schuifblad (RCD)

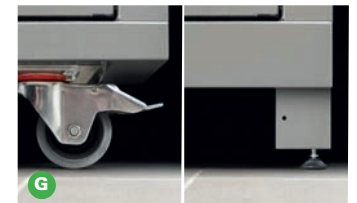

All tool cabinets with feet are fitted with full extension drawers

Tous les meubles de rangement pour outils avec pieds sont maintenant équipés de tiroirs à glissières à extension totale.

Alle Werkzeugschränke mit Füße jetzt mit vollständig herausziehbaren Schubladen.

Adesso tutti gli armadi per utensili con piedini sono dotati di cassetti di ampliamento totale.

Todos los armarios de herramientas con patas disponen de cajones de extensión total.

Alle opbergkasten voor gereedschap met poten nu met volledig verlengbare lades.



RCT-070F



1200mm Tool Storage Cabinets with adjustable feet



1200mm Meubles de rangement pour outils avec pieds ajustables
 1200mm Werkzeugschränke mit regelbare Füße
 Armadi per lo stoccaggio degli utensili da 1200 mm con piedini regolabili
 Armarios de almacenamiento de herramientas de 1200 mm con patas ajustables
 1200mm Opbergkasten voor gereedschap met Instelbare poten









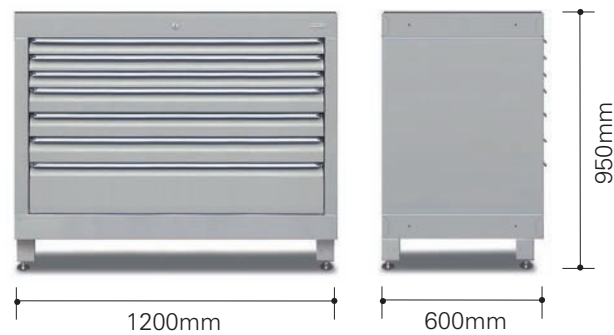











H 950mm, W 1200mm, D 600mm



MAX 400kg UDL



				
Drawer external depths Hauteur du tiroir, externe Schubladenhöhe - außen Altezza cassetto - esterna Altura del cajón - externa Hoogte lade - buitenkant	50mm	85mm	180mm	85mm
Drawer internal dimensions Dimensions du tiroir, interne Abmessungen der Schubladen - innen Dimensioni cassette - interne Dimensiones del cajón - internas Afmetingen lade - binnenkant	H 40mm W 1045mm D 487mm	H 72mm W 1045mm D 487mm	H 163mm W 1045mm D 487mm	H 72mm (58) W 1045mm (1017) D 487mm (351)
	 MAX 75kg UDL	 MAX 75kg UDL	 MAX 150kg UDL	 MAX 75kg UDL
RCT-070F 	3	3	1	.
RCT-060F 	3	1	2	.
RC-070F 	.	7	.	.
RC-060F 	.	5	1	.
RCB-060F 	.	5	1	.
RC-050F 	.	3	2	.
RCB-050F 	.	3	2	.
RCD-050F 	.	2	2	1
RC-040F 	.	1	3	.
RCD-040F 	.	.	3	1



RCT-070C



1200mm Tool Storage Cabinets with lockable castors



1200mm Meubles de rangement pour outils avec roulettes avec blocage intégré
1200mm Werkzeugschränke mit blockierbare Rollen











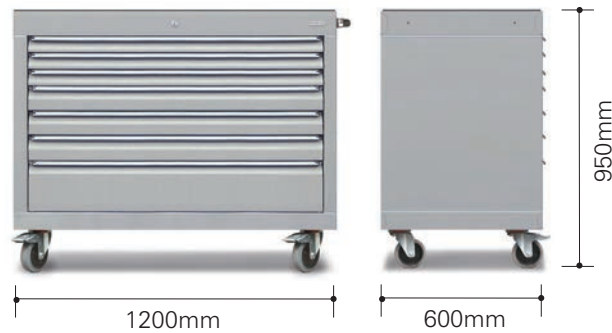



Armadi per lo stoccaggio degli utensili da 1200 mm con ruote orientabili bloccabili
Armarios de almacenamiento de herramientas de 1200 mm con ruedas giratorias bloqueables



1200mm Opbergkasten voor gereedschap met vergrendelbare wielen

H 950mm, W 1200mm, D 600mm

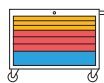
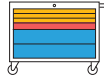
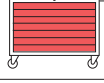
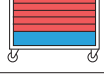

			
Drawer external depths Hauteur du tiroir, externe Schubladenhöhe - außen Altezza cassetto - esterna Altura del cajón - externa Hoogte lade - buitenkant	50mm 	85mm 	180mm 
Drawer internal dimensions Dimensions du tiroir, interne Abmessungen der Schubladen - innen Dimensioni cassetti - interne Dimensiones del cajón - internas Afmetingen lade - binnenkant	H 42mm W 1052mm D 490mm	H 73mm W 1052mm D 490mm	H 166mm W 1052mm D 490mm
			
RCT-070C 	3	3	1
RCT-060C 	3	1	2
RC-070C 	.	7	.
RC-060C 	.	5	1
RC-050C 	.	3	2
RC-040C 	.	1	3



RCT-907F



900mm Tool Storage Cabinets with adjustable feet









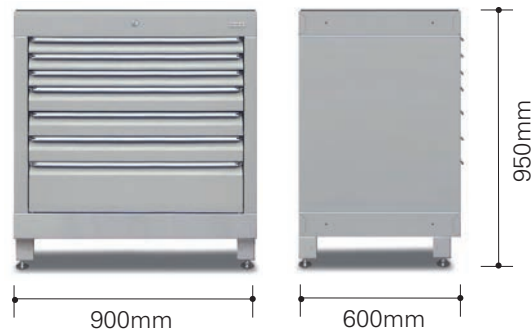





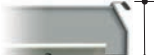







900mm Meubles de rangement pour outils avec pieds ajustables
 900mm Werkzeugschränke mit regelbare Füße
 Armadi per lo stoccaggio degli utensili da 900 mm con piedini regolabili
 Armarios de almacenamiento de herramientas de 900 mm con patas ajustables
 900mm Opbergkasten voor gereedschap met Instelbare poten



H 950mm, W 900mm, D 600mm



				
Drawer external depths Hauteur du tiroir, externe Schubladenhöhe - außen Altezza cassetto - esterna Altura del cajón - externa Hoogte lade - buitenkant	50mm 	85mm 	180mm 	85mm 
Drawer internal dimensions Dimensions du tiroir, interne Abmessungen der Schubladen - innen Dimensioni cassetti - interne Dimensiones del cajón - internas Afmetingen lade - binnenkant	H 40mm W 745mm D 487mm 	H 72mm W 745mm D 487mm 	H 163mm W 745mm D 487mm 	H 72mm (58) W 745mm (717) D 487mm (351) 
RCT-907F 	3	3	1	.
RCT-906F 	3	1	2	.
RC-907F 	.	7	.	.
RC-906F 	.	5	1	.
RCB-906F 	.	5	1	.
RC-905F 	.	3	2	.
RCB-905F 	.	3	2	.
RCD-905F 	.	2	2	1
RC-904F 	.	1	3	.
RCD-904F 	.	.	3	1



RCT-907C



900mm Tool Storage Cabinets with lockable castors



900mm Meubles de rangement pour outils avec roulettes avec blocage intégré
900mm Werkzeugschränke mit blockierbare Rollen



Armadi per lo stoccaggio degli utensili da 900 mm con ruote orientabili bloccabili
Armarios de almacenamiento de herramientas de 900 mm con ruedas giratorias bloqueables



900mm Opbergkasten voor gereedschap met vergrendelbare wielen

H 950mm, W 900mm, D 600mm

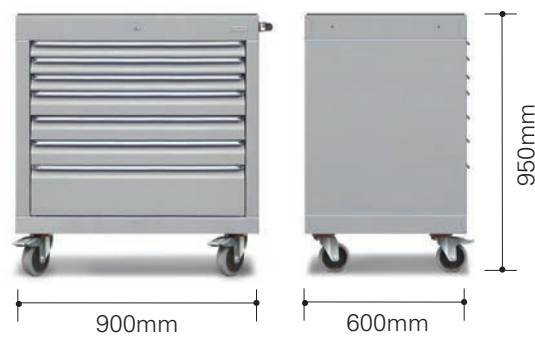

Drawer external depths

Hauteur du tiroir, externe
Schubladenhöhe - außen
Altezza cassetto - esterna
Altura del cajón - externa
Hoogte lade - buitenkant



50mm



85mm



180mm

Drawer internal dimensions

Dimensions du tiroir, interne
Abmessungen der Schubladen - innen
Dimensioni cassetti - interne
Dimensiones del cajón - internas
Afmetingen lade - binnenkant

H 42mm
W 752mm
D 490mm

H 73mm
W 752mm
D 490mm

H 166mm
W 752mm
D 490mm



RCT-907C

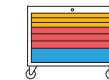

3

3

1

RCT-906C

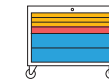

3

1

2

RC-907C

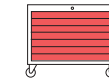

.

7

.

RC-906C

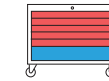

.

5

1

RC-905C

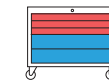

.

3

2

RC-904C

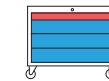

.

1

3



RC-606F



600mm Tool Storage Cabinets with adjustable feet



600mm Meubles de rangement pour outils avec pieds ajustables



600mm Werkzeugschränke mit regelbare Füße



Armadi per lo stoccaggio degli utensili da 600 mm con piedini regolabili

Armarios de almacenamiento de herramientas de 600 mm con patas ajustables

600mm Opbergkasten voor gereedschap met Instelbare poten



H 950mm, W 600mm, D 600mm



RC-606C



600mm Tool Storage Cabinets with lockable castors



600mm Meubles de rangement pour outils avec roulettes avec blocage intégré



600mm Werkzeugschränke mit blockierbare Rollen

Armadi per lo stoccaggio degli utensili da 600 mm con ruote orientabili bloccabili



Armarios de almacenamiento de herramientas de 600 mm con ruedas giratorias bloqueables

600mm Opbergkasten voor gereedschap met vergrendelbare wielen

H 950mm, W 600mm, D 600mm



600mm



600mm

950mm

Drawer external depths

Hauteur du tiroir, externe
Schubladenhöhe - außen
Altezza cassetto - esterna
Altura del cajón - externa
Hoogte lade - buitenkant



85mm

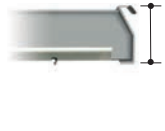

180mm



Drawer internal dimensions

Dimensions du tiroir, interne
Abmessungen der Schubladen - innen
Dimensioni cassetti - interne
Dimensiones del cajón - internas
Afmetingen lade - binnenkant

H 72mm
W 445mm
D 487mm



H 163mm
W 445mm
D 487mm



RC-606F



5

1

RC-605F



3

2

RC-604F



1

3



600mm



600mm

950mm

Drawer external depths

Hauteur du tiroir, externe
Schubladenhöhe - außen
Altezza cassetto - esterna
Altura del cajón - externa
Hoogte lade - buitenkant



85mm



180mm



Drawer internal dimensions

Dimensions du tiroir, interne
Abmessungen der Schubladen - innen
Dimensioni cassetti - interne
Dimensiones del cajón - internas
Afmetingen lade - binnenkant

H 73mm
W 452mm
D 490mm



H 166mm
W 452mm
D 490mm



RC-606C



5

1

RC-605C



3

2

RC-604C



1

3



RC-902F



RC-902C



Tool Storage Cabinets with extra-deep drawers

Armoires-coffres avec tiroirs extra profonds
 Werkzeugschränke mit extratiefen Schubladen extra tiefen
 Armadi per lo stoccaggio di utensili con cassetti molti profondi
 Armarios para herramientas con cajones extraprofundos
 Gereedschapskasten met extra diepe laden

**H 950mm, D 600mm,
 W 900/1200/1500/1800mm**

Tool cabinets with extra deep drawers have been developed to provide extra capacity for storing large automotive parts or tools. **Maximum weight per drawer is 100kg.**

Les armoires-coffres avec tiroirs extra profonds ont été conçues pour fournir une capacité de stockage supplémentaire pour les outils ou pièces automobiles volumineux. **Le poids maximal par tiroir est de 100 kg.**

Werkzeugschränke mit extra tiefen Schubladen bieten zusätzliche Kapazität zum Lagern von großen Automobilteilen oder Werkzeugen. **Das maximale Gewicht pro Schublade beträgt 100 kg.**

Gli armadi per lo stoccaggio degli utensili con cassetti extra profondi sono stati pensati per fornire capienza aggiuntiva per riporre componenti automotive o strumenti di grandi dimensioni. **Il peso massimo consentito per cassetto è di 100 kg.**

Los armarios para herramientas con cajones extraprofundos se han desarrollado a fin de ofrecer una capacidad adicional para guardar herramientas o piezas de automoción grandes. **El peso máximo por cajón es de 100 kg.**

Gereedschapskasten met extra diepe laden zijn ontworpen om extra opslagruimte te creëren voor grote auto-onderdelen of gereedschappen. **Maximum gewicht per lade: 100 kg.**

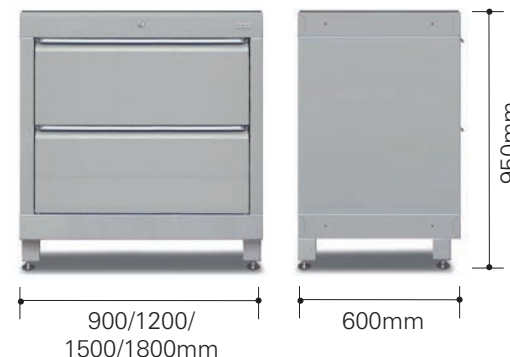

Drawer internal dimensions

Dimensions du tiroir, interne
 Abmessungen der Schubladen - innen
 Dimensioni cassetti - interne
 Dimensiones del cajón - internas
 Afmetingen lade - binnenkant



RC-902F	W 900mm		H 248 W 745 D 470mm	
RC-020F	W 1200mm		H 248 W 1045 D 470mm	
RC-152F	W 1500mm		H 248 W 1345 D 470mm	
RC-182F	W 1800mm		H 248 W 1645 D 470mm	

Drawer internal dimensions

Dimensions du tiroir, interne
 Abmessungen der Schubladen - innen
 Dimensioni cassetti - interne
 Dimensiones del cajón - internas
 Afmetingen lade - binnenkant



RC-902C	W 900mm		H 251 W 752 D 473mm	
RC-020C	W 1200mm		H 251 W 1045 D 473mm	



RCH-110



1200mm Multi-Drawer High Tool Storage Cabinets



1200mm Armoires à outils hautes à tiroirs multiples (avec pieds ajustables)
1200mm Hohem Werkzeugschränken mit Mehrere Schubladen (mit regelbare Füße)











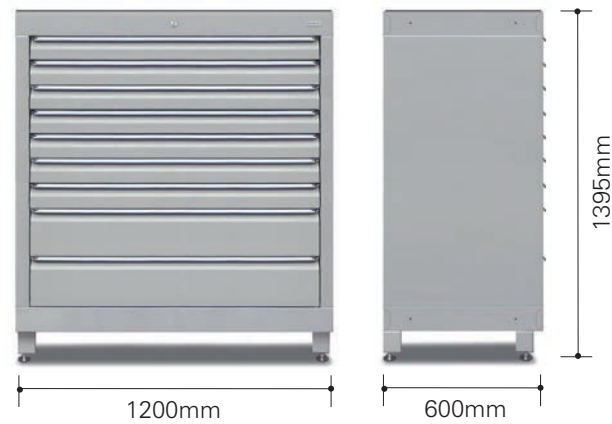

Alta Armadi per utensili da 1200 mm con più cassetti (con piedini regolabili)
Alta armarios de herramienta de 1200mm con varios cajones (con patas ajustables)



1200mm Multi-lade hoge gereedschaps kasten met Instelbare poten

H 1395mm, W 1200mm, D 600mm

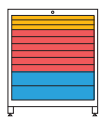
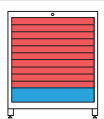
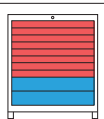
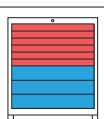

			
Drawer external depths Hauteur du tiroir, externe Schubladenhöhe - außen Altezza cassetto - esterna Altura del cajón - externa Hoogte lade - buitenkant	50mm 	85mm 	180mm 
Drawer internal dimensions Dimensions du tiroir, interne Abmessungen der Schubladen - innen Dimensioni cassetti - interne Dimensiones del cajón - internas Afmetingen lade - binnenkant	H 40mm W 1045mm D 487mm	H 72mm W 1045mm D 487mm	H 163mm W 1045mm D 487mm
	 MAX 75kg UDL	 MAX 75kg UDL	 MAX 150kg UDL
RCTH-111 	3	6	2
RCH-111 	.	10	1
RCH-110 	.	8	2
RCH-109 	.	6	3



RCH-910



900mm Multi-Drawer High Tool Storage Cabinets



900mm Armoires à outils hautes à tiroirs multiples (avec pieds ajustables)
 900mm Hohem Werkzeugschränken mit Mehrere Schubladen (mit regelbare Füße)



Alta Armadi per utensili da 900 mm con più cassetti (con piedini regolabili)
 Alta armarios de herramienta de 900mm con varios cajones (con patas ajustables)



900mm Multi-lade hoge gereedschaps kasten met Instelbare poten
H 1395mm, W 900mm, D 600mm

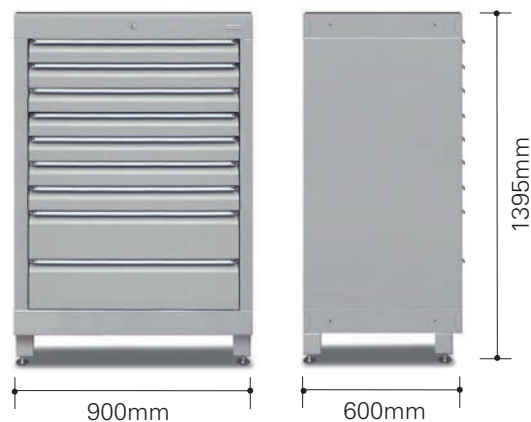

Drawer external depths

Hauteur du tiroir, externe
 Schubladenhöhe - außen
 Altezza cassetto - esterna
 Altura del cajón - externa
 Hoogte lade - buitenkant



50mm



85mm



180mm

Drawer internal dimensions

Dimensions du tiroir, interne
 Abmessungen der Schubladen - innen
 Dimensioni cassetti - interne
 Dimensiones del cajón - internas
 Afmetingen lade - binnenkant

H 40mm
 W 745mm
 D 487mm

H 72mm
 W 745mm
 D 487mm

H 163mm
 W 745mm
 D 487mm



RCTH-911



3

6

2

RCH-911



.

10

1

RCH-910



.

8

2

RCH-909



.

6

3







Tool storage cabinets with vertical drawers

Meubles de rangement d'outils à tiroirs verticaux
 Werkzeugschränke mit vertikalen Schubladen
 Armadi per lo stoccaggio di utensili con cassetti verticali
 Armarios de almacenamiento de herramientas con cajones verticales
 Opbergkasten voor gereedschap met verticale laden



VSD-030







H 2000mm, W 300mm, D 600mm

-  A narrow, space-saving tool storage cabinet, with a single lockable vertical drawer containing a double sided square peg panel. Includes adjustable feet.
-  Meuble de rangement compact étroit, pour outils, avec tiroir vertical unique à serrure, présentant un panneau perforé double face. Pieds réglables.
-  Ein schmaler, platzsparender Werkzeugschrank mit einer abschließbaren vertikalen Schublade mit beidseitig quadratischer Lochplatte. Einschließlich einstellbarer Füße
-  Un armadio per lo stoccaggio di utensili stretto e poco ingombrante con un unico cassetto verticale chiudibile a chiave, contenente un pannello a due facce con fori quadrati. Include dei piedini regolabili.
-  Un armario de almacenamiento de herramientas estrecho para ahorrar espacio, con un solo cajón vertical con cerradura y que incluye un panel perforado cuadrado de doble cara. Incluye patas ajustables.
-  Een smalle, ruimtebesparende opbergkast voor gereedschap met een enkelvoudige afsluitbare verticale lade die een dubbelzijdig paneel met vierkante perforaties bevat. Inclusief verstelbare poten



VSD-031







H 950mm, W 300mm, D 600mm

-  A narrow, space-saving tool storage cabinet, with a single lockable vertical drawer containing a double sided square peg panel. Includes adjustable feet and a hard-wearing composite worksurface.
-  Meuble de rangement compact étroit, pour outils, avec tiroir vertical unique à serrure, présentant un panneau perforé double face. Pieds réglables et plan de travail anti-usure en matériau composite.
-  Ein schmaler, platzsparender Werkzeugschrank mit einer abschließbaren vertikalen Schublade mit beidseitig quadratischer Lochplatte. Einschließlich einstellbarer Füße und robuster Arbeitsoberfläche aus Verbundwerkstoff.
-  Un armadio per lo stoccaggio di utensili stretto e poco ingombrante con un unico cassetto verticale chiudibile a chiave, contenente un pannello a due facce con fori quadrati. Include dei piedini regolabili e una resistente superficie di lavoro in composito.
-  Un armario de almacenamiento de herramientas estrecho para ahorrar espacio, con un solo cajón vertical con cerradura y que incluye un panel perforado cuadrado de doble cara. Incluye patas ajustables y superficie de trabajo de material compuesto muy resistente al desgaste.
-  Een smalle, ruimtebesparende opbergkast voor gereedschap met een enkelvoudige afsluitbare verticale lade die een dubbelzijdig paneel met vierkante perforaties bevat. Inclusief verstelbare poten en een slijtagebestendig composietwerkoppervlak.



BU-031

H 950mm, W 300mm, D 600mm

-  A narrow, space-saving tool storage cabinet, with a lockable vertical deep drawer and a smaller inner drawer. Includes adjustable feet and a hard-wearing composite worksurface.
-  Meuble de rangement compact étroit, pour outils, avec tiroir vertical profond à serrure et petit tiroir intérieur. Pieds réglables et plan de travail anti-usure en matériau composite.
-  Ein schmaler, platzsparender Werkzeugschrank mit abschließbarer tiefer vertikaler Schublade und einer kleineren Innenschublade. Einschließlich einstellbarer Füße und robuster Arbeitsoberfläche aus Verbundwerkstoff.
-  Un armadio per lo stoccaggio di utensili stretto e poco ingombrante con un profondo cassetto verticale chiudibile a chiave ed un cassetto interno più piccolo. Include dei piedini regolabili e una resistente superficie di lavoro in composito.
-  Un armario de almacenamiento de herramientas estrecho para ahorrar espacio, con un cajón profundo vertical con cerradura y un cajón interior más pequeño. Incluye patas ajustables y superficie de trabajo de material compuesto muy resistente al desgaste.
-  Een smalle, ruimtebesparende opbergkast voor gereedschap met een afsluitbare verticale diepe lade en een kleinere binnenlade. Inclusief verstelbare poten en een slijtagebestendig composietwerkoppervlak.

Mobile Workstations

Postes de travail mobiles

Mobile Arbeitsplätze

Banchi di lavoro mobili

Puestos de trabajo móviles

Mobiele Werkstations



Mobile Workstations

Product features include:

- A** Heavy-duty epoxy coated 1.2mm steel construction
- B** Hard-wearing composite worksurface
- C** Fully lockable cabinet
- D** Handle for easy movement
- E** Laptop drawer
- F** Drawers available in two configurations with handle slots for labels. Foam inlay for drawers as standard
- G** Peg panel for tool storage with vertical movement (tools not included)
- H** Anti-tilt mechanism
- I** Lockable castors
- J** Towel drawer + Aerosol drawer

Postes de travail mobiles

Les caractéristiques du produit comprennent:

- A** Structure en acier de 1,2mm recouverte d'une couche de résine époxydique hautement résistante
- B** Surface de travail en composite résistant à l'usure
- C** Meuble de rangement entièrement verrouillable
- D** Poignée ergonomique
- E** tiroir pour ordinateurs portables
- F** Deux options de configuration de tiroirs avec des emplacements pour étiquettes dans la poignée. Incrustation de mousse de série pour les tiroirs
- G** Panneau perforé à hauteur réglable pour le rangement des outils (outils non inclus)
- H** Mécanisme anti-basculement
- I** Roulettes avec blocage intégré
- J** Tiroir pour serviettes + Tiroir pour aérosols

Mobile Arbeitsplätze

Die Produkteigenschaften umfassen:

- A** Mit Epoxidharz ummantelte 1,2mm Stahlkonstruktion für hohe Beanspruchungen
- B** Verschleißfeste Arbeitsoberfläche aus Verbundwerkstoff
- C** Völlig verschließbarer Schrank
- D** Griff für einfaches Fortbewegen
- E** Laptop-Schublade
- F** In zwei Konfigurationen verfügbare Schubladen mit Einschubschlitzen für Etiketten in den Griffen. Schaumstoffeinlage für Schubladen standardmäßig
- G** Lochplatte für Werkzeugaufbewahrung mit vertikaler Bewegung (Werkzeuge nicht inbegriffen)
- H** Antikipp-Mechanismus
- I** Blockierbare Rollen
- J** Handtuch-Schublade + Aerosol-Schublade

Banchi di lavoro mobili

Le caratteristiche del prodotto comprendono:

- A** Struttura di acciaio di 1,2 mm rivestita di resine epossidiche resistenti
- B** Superficie di lavoro di composto inalterabile
- C** Armadio completamente chiudibile a chiave
- D** Maniglia per un facile spostamento
- E** Cassetto per laptop
- F** Cassetti disponibili in due configurazioni con maniglie con possibilità di inserire etichette. Gommapiuma per cassetti in dotazione
- G** Supporto perforato per lo stoccaggio degli utensili con movimento verticale (utensili non inclusi)
- H** Meccanismo anti-ribaltamento
- I** Ruote orientabili bloccabili
- J** Cassetto per asciugamani + Cassetto per aerosol

Puestos de trabajo móviles

El producto tiene las características siguientes:

- A** Fabricación robusta de acero de 1,2 mm con revestimiento epoxi
- B** Superficie de trabajo compuesta resistente
- C** Armario totalmente cerrado con llave
- D** Empuñadura para desplazamiento fácil
- E** Cajon para computadoras portátiles
- F** Cajones disponibles en dos configuraciones con ranuras en las manijas para etiquetas. Revestimiento de espuma para los cajones en estándar
- G** Panel interno perforado para almacenamiento de herramientas con movimiento vertical (herramientas no incluidas)
- H** Mecanismo antibasculamiento
- I** Ruedas giratorias bloqueables
- J** Cajon para toallas + Cajon para aerosoles

Mobiele Werkstations

Technische kenmerken:

- A** Zwarte stalen constructie 1.2mm met epoxy coating
- B** Onaantastbaar composiet werkoppervlak
- C** Volledig afsluitbare kast
- D** Hendel voor eenvoudige verplaatsing
- E** Lade voor laptop
- F** Lades beschikbaar in twee configuraties met gleuven voor etiketten in de handvaten. Standaard schuimrubberen inlay voor lades
- G** Geperforeerde wanden voor opslag van gereedschap met verticale beweging (gereedschap niet inbegrepen)
- H** Anti-kantel mechanisme
- I** Vergrendelbare wielen
- J** Lade voor handdoek + Lade voor aerosol

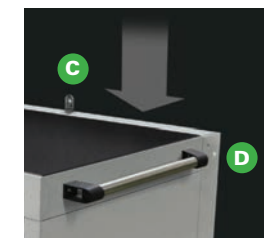

Vertical peg panel can be retracted and locked into the cabinet.

Le panneau perforé vertical peut être escamoté et bloqué dans le meuble de rangement.

Senkrechte Lochplatte kann eingefahren und im Schrank befestigt werden.

Il supporto perforato verticale può essere ritratto e chiuso nell'armadio.

El panel interno perforado vertical puede insertarse y bloquearse al interior del armario.

De verticale geperforeerde panelen kunnen worden ingetrokken en in de kast worden opgenomen.

Drawer external depths

Hauteur du tiroir, externe
Schubladenhöhe - außen
Altezza cassetto - esterna
Altura del cajón - externa
Hoogte lade - buitenkant



85mm



180mm



Drawer internal dimensions

Dimensions du tiroir, interne
Abmessungen der Schubladen - innen
Dimensioni cassetti - interne
Dimensiones del cajón - internas
Afmetingen lade - binnenkant

H 73mm
W 494mm
D 475mm



H 166mm
W 494mm
D 475mm



Total capacity / Capacité totale /
Gesamtkapazität / Capacità totale /
La capacidad total / Totale capaciteit





Mobile workstation with laptop, towel and aerosol drawers

Poste de travail mobile avec tiroirs pour ordinateurs portables, serviettes et aérosols
 Mobile Arbeitsplatz mit Laptop-, Handtuch- und Aerosol Schubladen
 Banco da lavoro mobile con cassetti per laptop, asciugamani e aerosol
 Puesto de trabajo móvil con cajones para computadoras portátiles, toallas y aerosoles
 Mobiel Werkstation met laptop-, handdoek- en aerosolladen

H 950 (1510)mm, W 1050mm, D 700mm



Laptop drawer
 Tiroir pour ordinateurs portables
 Laptop-Schublade
 Cassetto per laptop
 Cajon para computadoras portátiles
 Lade voor laptop

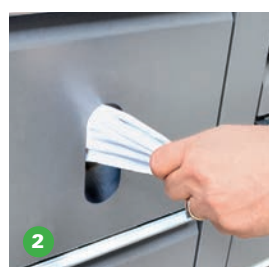

Towel drawer
 Tiroir pour serviettes
 Handtuch-Schublade
 Cassetto per asciugamani
 Cajon para toallas
 Lade voor handdoek

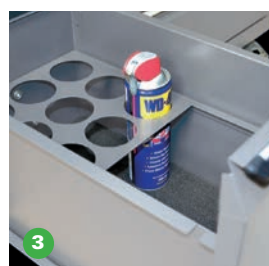

Aerosol drawer
 Tiroir pour aérosols
 Aerosol-Schublade
 Cassetto per aerosol
 Cajon para aerosoles
 Lade voor aerosol

VTC-1054

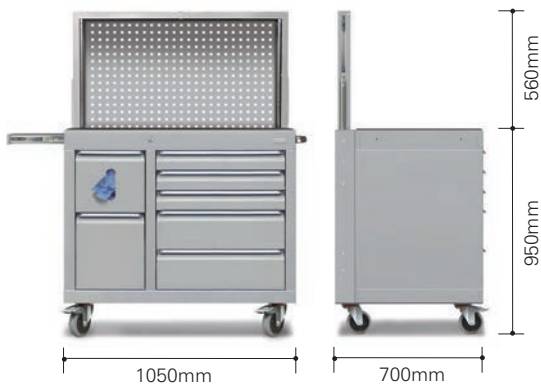

Mobile workstations with cupboard

Postes de travail mobiles avec meuble de rangement
 Mobile Arbeitsplätze mit integrierter Schrank
 Banchi di lavoro mobili con Armadio integrato
 Puestos de trabajo móviles con espacio integrado
 Mobiele Werkstations met geïntegreerde kast

H 950 (1510)mm, W 1050mm, D 700mm



Integrated cupboard with adjustable shelf
 Armoire intégrée avec tablette réglable
 Integrierter Schrank mit verstellbarem Einlegeboden
 Armadio integrato con ripiano regolabile
 Espacio integrado con repisa ajustable
 Geïntegreerde kast met instelbare legplank

VTC-1050

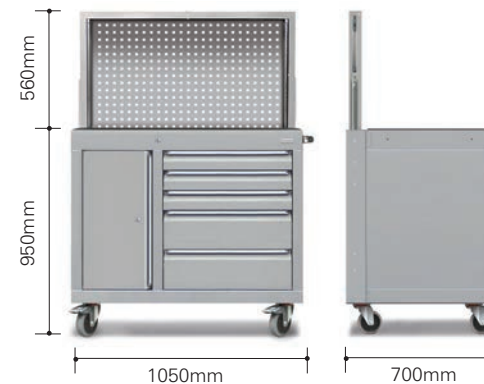
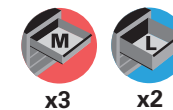

Hooks to fit to square peg system
 Crochets adaptés au système de perforations carrées
 Haken, die in das quadratische Lochplattensystem
 Ganci da fissare al pannello perforato quadrato
 Ganchos para fijar al sistema de perforaciones cuadradas
 Haken voor systeem met vierkanten gaten

p114-115

Under-bench Tool Storage Cabinets and Bridging Units

Meubles de rangement des outils sous l'établi
et les unités de pontage

Werkzeugschränke unter der Werkbank
und Verbindungseinheiten

Armadi per lo stoccaggio degli utensili da posizionare sotto scrivanie
e unita' di collegamento

Armarios de almacenamiento de herramientas bajo el banco
y unidades de unión

Opbergkasten voor gereedschap onder werkbank
en overbruggingsstukken



Under-bench tool cabinets and bridging units

Mobile cabinets designed to fit beneath bridging units and between fixed cabinets for complete flexibility to move around the workshop. Bridging units provide a continuous worksurface with space below for seating, bowsers or other workshop equipment.

Product features include:

- A** 600, 900 or 1200mm width bridging units
- B** 840mm high cabinets to fit beneath bridging units
- C** Drawers available in three depths with handle slots for labels
- D** Lockable castors
- E** Create space for other equipment

Meubles de rangement des outils sous l'établi et les unités de pontage

Des meubles de rangements mobiles conçus pour s'intégrer sous les unités de pontage et entre les meubles fixes pour permettre de les déplacer facilement dans tout l'atelier. Les unités de pontage offrent une surface de travail continue avec de l'espace en dessous pour les sièges, les ravitailleurs ou tout autre équipement de l'atelier.

Les caractéristiques du produit comprennent:

- A** Unités de pontage de 600, 900 ou 1200mm de large
- B** Meubles de rangement de 840mm de hauteur pour s'intégrer sous les unités de pontage
- C** Tiroirs disponibles en 3 profondeurs avec des emplacements pour étiquettes dans la poignée
- D** Roulettes à blocage intégré
- E** Espace disponible pour tout autre équipement

Werkzeugschränke unter der Werkbank und Verbindungseinheiten

Bewegliche Schränke, die dafür entwickelt wurden, unter Verbindungseinheiten und zwischen feste Schränke zu passen, wodurch beliebige Ortswechsel innerhalb der Werkstatt möglich werden. Verbindungseinheiten stellen eine kontinuierliche Arbeitsfläche zur Verfügung, wobei darunter Raum zum Sitzen, für Zapfsäulen oder andere Werkstattausrüstung sind.

Die Produkteigenschaften umfassen:

- A** 600, 900 oder 1200mm breite Verbindungseinheiten
- B** 840mm hohe Schränke, die unter die Verbindungseinheiten passen
- C** Schubladen mit Einschubschlitzen in den Griffen für Etiketten. In 3 Tiefen erhältlich
- D** Blockierbare Rollen
- E** Erzeugt Platz für andere Ausrüstungsgegenstände

Armadi per lo stoccaggio degli utensili da posizionare sotto scrivanie e unità di collegamento

Armadi mobili creati per essere messi sotto le unità di collegamento e sotto armadi fissi per ottenere una flessibilità di movimento completa nell'officina. Le unità di collegamento forniscono una superficie di lavoro continua lasciando al di sotto lo spazio per sedere, per le cisterne o le altre attrezzature dell'officina.

Le caratteristiche del prodotto comprendono:

- A** unità di collegamento larghe 600, 900 o 1200mm
- B** armadi alti 840mm da posizionare sotto le unità di collegamento
- C** Cassetti disponibili in 3 profondità con maniglie con possibilità di inserire etichette
- D** Ruote orientabili bloccabili
- E** Creazione di spazio per altre attrezzature

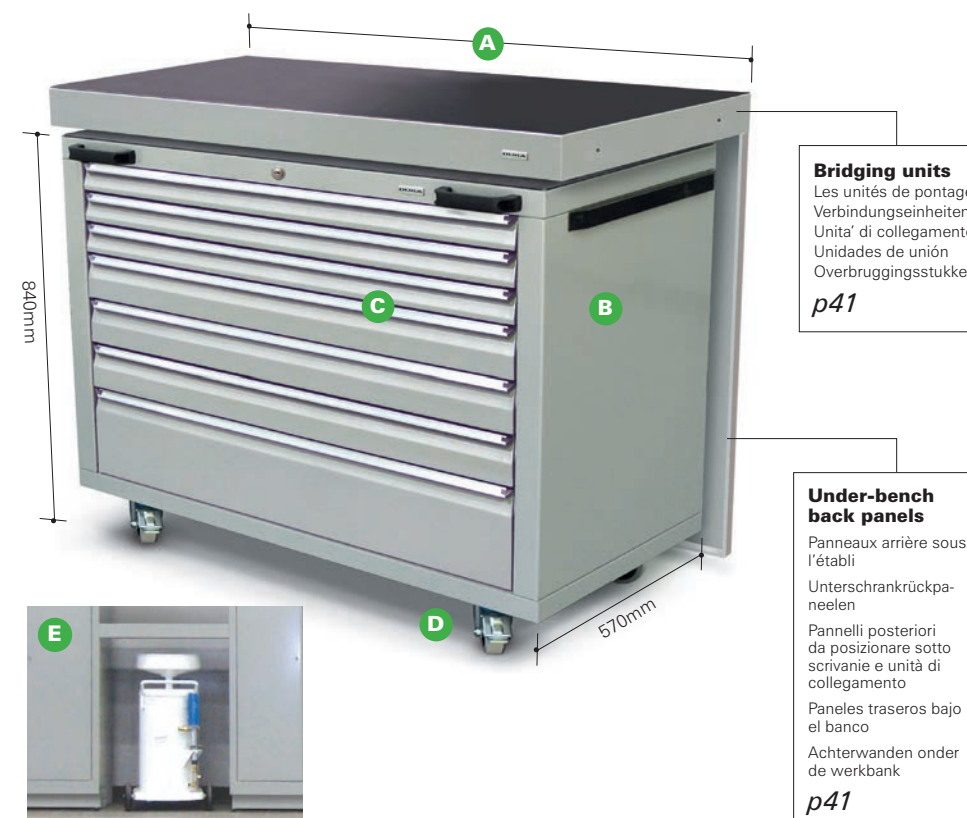

Bridging units
Les unités de pontage
Verbindungseinheiten
Unità di collegamento
Unidades de unión
Overbruggingsstukken
p41

Under-bench back panels
Panneaux arrière sous l'établi
Unterschrankrückpanneelen
Pannelli posteriori da posizionare sotto scrivanie e unità di collegamento
Paneles traseros bajo el banco
Achterwanden onder de werkbank
p41

Armarios de almacenamiento de herramientas bajo el banco y unidades de unión

Los armarios móviles diseñados para instalarse bajo las unidades de unión y entre los armarios fijos para una gran flexibilidad de desplazamiento en el taller. Las unidades de unión ofrecen una superficie de trabajo continua con un espacio inferior para alojar bombas u otro equipo de taller.

El producto tiene las características siguientes:

- A** Unidades de unión de 600, 900 o 1200mm de ancho
- B** Armarios de 840mm de altura para instalar bajo las unidades de unión
- C** Cajones disponibles en 3 profundidades con ranuras en las manijas para las etiquetas
- D** Ruedas giratorias bloqueables
- E** Crean espacio para otros equipos

Opbergkasten voor gereedschap onder werkbank en overbruggingsstukken

Verplaatsbare kasten voor onder overbruggingsstukken en tussen vaste kasten om zich in alle vrijheid rond de werkplaats te bewegen. Overbruggingsstukken zorgen voor extra werkoppervlak met ruimte onder voor stoelen, tankwagens en andere uitrustingen.

Technische kenmerken:

- A** Overbruggingsstukken 600, 900 en 1200mm breed
- B** Kasten 840mm hoog, voor onder overbruggingsstuk
- C** Laden leverbaar in 3 verschillende dieptes met gleuven voor labels
- D** Vergrendelbare wielen
- E** Scheppen ruimte voor andere uitrusting



1160mm Under-Bench Tool Cabinets

1160mm Meubles de rangement des outils sous l'établi
 1160mm Werkzeugschränke unter der Werkbank
 Armadi per lo stoccaggio degli utensili da 1160 mm da posizionare sotto scrivanie
 Armarios de almacenamiento de herramientas de 1160 mm bajo el banco
 1160mm Opbergkasten voor gereedschap onder werkbank

H 840mm, W 1160mm, D 570mm

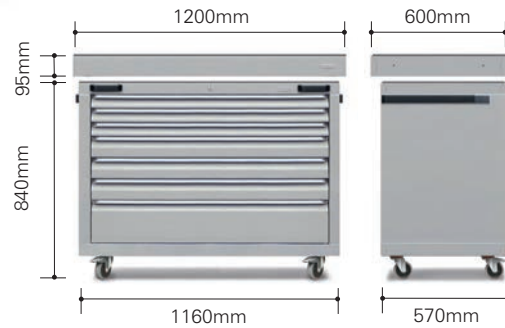

UCT-1207



860mm Under-Bench Tool Cabinets

860mm Meubles de rangement des outils sous l'établi
 860mm Werkzeugschränke unter der Werkbank
 Armadi per lo stoccaggio degli utensili da 860 mm da posizionare sotto scrivanie
 Armarios de almacenamiento de herramientas de 860 mm bajo el banco
 860mm Opbergkasten voor gereedschap onder werkbank

H 840mm, W 860mm, D 570mm

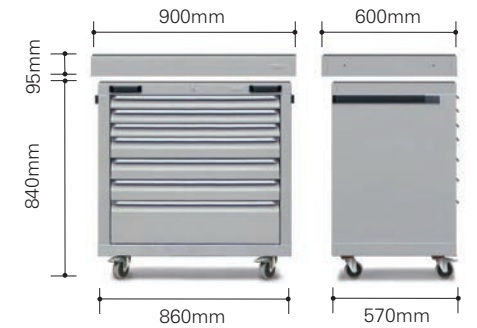

UCT-0907



Drawer external depths Hauteur du tiroir, externe Schubladenhöhe - außen Altezza cassetto - esterna Altura del cajón - externa Hoogte lade - buitenkant	50mm	85mm	180mm
	Drawer internal dimensions Dimensions du tiroir, interne Abmessungen der Schubladen - innen Dimensioni cassetti - interne Dimensiones del cajón - internas Afmetingen lade - binnenkant	H 42mm W 1012mm D 460mm 	H 73mm W 1012mm D 460mm
UCT-1207	3	3	1
UCT-1206	3	1	2
UC-1207C	.	7	.
UC-120C	.	5	1

Drawer external depths Hauteur du tiroir, externe Schubladenhöhe - außen Altezza cassetto - esterna Altura del cajón - externa Hoogte lade - buitenkant	50mm	85mm	180mm
	Drawer internal dimensions Dimensions du tiroir, interne Abmessungen der Schubladen - innen Dimensioni cassetti - interne Dimensiones del cajón - internas Afmetingen lade - binnenkant	H 42mm W 712mm D 460mm 	H 73mm W 712mm D 460mm
UCT-0907	3	3	1
UCT-0906	3	1	2
UC-0907C	.	7	.
UC-090C	.	5	1



UCT-0607

560mm Under-Bench Tool Cabinets

560mm Meubles de rangement des outils sous l'établi
 560mm Werkzeugschränke unter der Werkbank
 Armadi per lo stoccaggio degli utensili da 560 mm da posizionare sotto scrivanie
 Armarios de almacenamiento de herramientas de 560 mm bajo el banco
 560mm Opbergkasten voor gereedschap onder werkbank

H 840mm, W 560mm, D 570mm

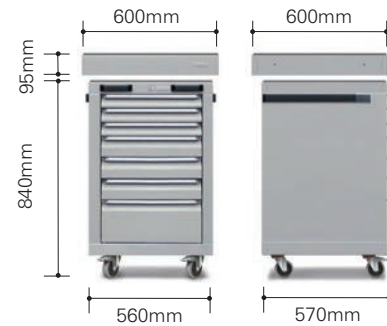

Drawer external depths

Hauteur du tiroir, externe
 Schubladenhöhe - außen
 Altezza cassetto - esterna
 Altura del cajón - externa
 Hoogte lade - buitenkant



50mm



85mm



180mm

Drawer internal dimensions

Dimensions du tiroir, interne
 Abmessungen der Schubladen - innen
 Dimensioni cassetti - interne
 Dimensiones del cajón - internas
 Afmetingen lade - binnenkant

H 42mm
 W 412mm
 D 460mm



H 73mm
 W 412mm
 D 460mm



H 165mm
 W 412mm
 D 460mm



UCT-0607



3

3

1

UCT-0606



3

1

2

UC-0607C



.

7

.

UC-060C



.

5

1



BR-009

Bridging Units

Les unités de pontage
 Verbindungseinheiten
 Unità di collegamento
 Unidades de unión
 Overbruggingsstukken

- BR-210 2100mm
- BR-180 1800mm
- BR-150 1500mm
- BR-009 1200mm
- BR-090 900mm
- BR-008 600mm



BRD-120

Bridging Units with a drawer

Unités de pontage avec tiroir
 Verbindungseinheiten mit einer Schublade
 Unità di collegamento con un cassetto
 Unidades de unión con un cajón
 Overbruggingsunits met een lade

- BRD-120 1200mm
- BRD-090 900mm
- BRD-060 600mm



BRI-120

Under-Bench Back Panels

Panneaux arrière sous l'établi
 Unterschrankrückpaneele
 Pannelli posteriori da posizionare sotto scrivanie e unità di collegamento
 Paneles traseros bajo el banco
 Achterwanden onder de werkbank

- BRI-210 2100mm
- BRI-180 1800mm
- BRI-150 1500mm
- BRI-120 1200mm
- BRI-090 900mm
- BRI-060 600mm

STANDARD

EXTENDED

- BRIE-210 2100mm
- BRIE-180 1800mm
- BRIE-150 1500mm
- BRIE-120 1200mm
- BRIE-090 900mm
- BRIE-060 600mm

Vertical Special Service Tool Cabinets

Rangements verticaux spéciaux pour outils lourds

Vertikale Schränke für spezielle Servicewerkzeuge

Armadi per attrezzi speciali verticali

Armarios verticales para herramientas de servicio especiales

Verticale kasten voor speciaal gereedschap



Vertical Special Service Tool Cabinets

Heavy-duty secure special service tool cabinet with sliding drawers.

Product features include:

- A** 3 x double-sided drawers with peg panels
- B** 1 x drawer with 5 baskets for larger tools
- C** Cam lock system
- D** Large stainless steel handles
- E** Safety legs
- F** Adjustable feet

Rangements verticaux spéciaux pour outils lourds

Rangement spécial sécurisé pour outils lourds avec tiroirs coulissants.

Les caractéristiques du produit comprennent:

- A** 3 x tiroirs à deux faces avec panneaux perforés
- B** Tiroir vertical avec 5 paniers pour les grands outils
- C** Système de verrouillage à came
- D** Grandes poignées en acier inoxydable
- E** Jambes de sécurité
- F** Pieds ajustables

Vertikale Schränke für spezielle Servicewerkzeuge

Sichere Servicewerkzeugschränke für hohe Beanspruchung mit gleitenden ausziehbaren Wänden.

Die Produkteigenschaften umfassen:

- A** 3 x doppelseitige Schubladen mit Lochplatten
- B** Vertikale Schubladen mit 5 Körben für größere Werkzeuge
- C** Nockenverriegelungssystem
- D** Große Edelstahlgriffe
- E** Sicherheitsbeine
- F** Regelbare Füße

Armadi per attrezzi speciali verticali

Armadi per attrezzi speciali sicuro e resistente con cassetti.

Le caratteristiche del prodotto comprendono:

- A** 3 x cassetti a due face con pannelli forati
- B** Cassetto verticale con 5 ceste per attrezzi lunghi
- C** Sistema di blocco della camma
- D** Grandi maniglie in acciaio inossidabile
- E** Gambe di sicurezza
- F** Piedini regolabili

Armarios verticales para herramientas de servicio especiales

Armario para herramientas especiales robusto y seguro con cajones.

El producto tiene las características siguientes:

- A** 3 cajones con dos lados de panel perforado
- B** Cajón vertical con 5 canastas para herramientas grandes
- C** Sistema de bloqueo de levas
- D** Grandes manijas de acero inoxidable
- E** Piernas de seguridad
- F** Patas ajustables

Verticale kasten voor speciaal gereedschap

Zware veilige kast voor speciaal gereedschap met schuifladen

Technische kenmerken:

- A** 3 x dubbelzijdige laden met geperforeerd paneel
- B** Verticale lade met 5 manden voor breder gereedschap
- C** Cam sluitsysteem
- D** Grote roestvrij stalen handvatten
- E** Veiligheidsbenen
- F** Verstelbare poten

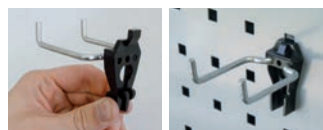

Hooks to fit to square peg system

Crochets adaptés au système de perforations carrées
 Haken, die in das quadratische Lochlattensystem
 Ganci da fissare al pannello perforato quadrato
 Ganchos para fijar al sistema de perforaciones cuadradas
 Haken voor systeem met vierkanten gaten

p114-115



VSD-121 H 2000mm, W 1200mm, D 1000mm
VSD-128 H 2000mm, W 1200mm, D 800mm

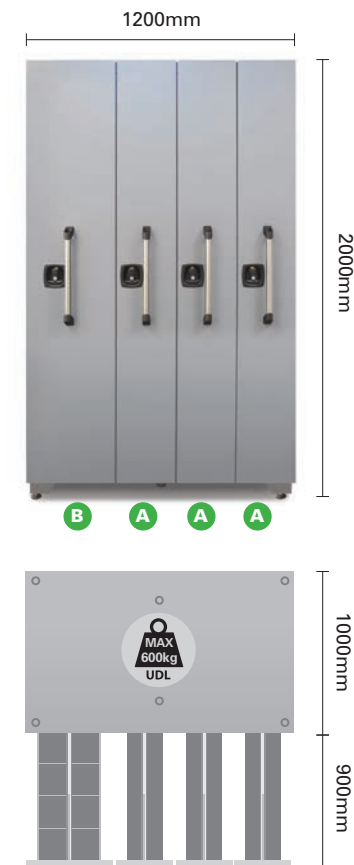

A Peg panel drawers



B Basket drawer



C Cam lock system



D Large handles



E Safety legs



F Adjustable feet

Integrated Fluid Management

Gestion des fluides intégrée
Integriertes Flüssigkeitsmanagement
Gestione integrata dei fluidi
Gestión de fluido integrada
Geïntegreerd vloeistofbeheer



Integrated fluid management

Flexible and efficient solutions for managing oil, air and water, avoiding spillages and improving health and safety. Three modular widths of 600, 900 and 1200mm.

Product features include:

- A** Quick release access panel or vertical opening door with oil monitoring keypad
- B** Optional oil extraction controls
- C** Upper reels for oil delivery/extraction or water
- D** Stainless-steel quick-access maintenance panels
- E** Removable stainless steel drip tray with optional oil capture tube
- F** Lower reels for air delivery with quick release access panel
- G** Protective metal rollers for reels
- H** Integrated shut-off valves

Gestion des fluides intégrée

Des solutions flexibles et efficaces pour la gestion d'huile, de l'air et de l'eau, en évitant les gaspillages et en améliorant la santé et la sécurité. Trois largeurs modulaires de 600, 900 et 1200mm.

Les caractéristiques du produit comprennent:

- A** Panneau d'accès ou porte verticale à ouverture rapide avec clavier de contrôle de l'huile
- B** Commandes optionnelles d'extraction d'huile
- C** Enrouleurs supérieurs pour l'arrivée/l'extraction d'huile ou d'eau
- D** Panneaux d'entretien en acier inox, avec accès rapide
- E** Bac récepteur amovible en acier inoxydable avec tuyau capteur d'huile en option
- F** Enrouleurs inférieurs pour l'arrivée d'air avec panneau d'accès rapide
- G** Galets de protection en métal pour les enrouleurs
- H** Valves d'arrêt intégrées

Integriertes Flüssigkeitsmanagement

Flexible und effiziente Lösungen für das Management von Öl, Luft und Wasser, was Verschütten vermeidet und Sicherheit und Arbeitsschutz verbessert. Module in drei verschiedenen Größen: 600, 900 und 1200mm.

Die Produkteigenschaften umfassen:

- A** Schnellfreigabepaneel, oder vertikale Öffnungstür mit Ölkontrolltastatur
- B** Öl Ablaufkontrolle auf Wunsch
- C** Obere Aufroller für Ölzufuhr/-ablauf oder Wasser
- D** Schnellzugangs-Wartungsplatten aus Edelstahl
- E** Abnehmbare Auffangwanne aus Edelstahl mit Ölaufangrohr auf Wunsch
- F** Untere Aufroller für Luftzufuhr mit Schnellfreigabepaneel
- G** Metallschutzrollen für Aufroller
- H** Integrierte Absperrventile

Gestione integrata dei fluidi

Soluzioni flessibili ed efficienti per gestire l'olio, l'aria e l'acqua, evitando le perdite e migliorando la salute e la sicurezza. Tre larghezze modulari 600, 900 e 1200mm.

Le caratteristiche del prodotto comprendono:

- A** Pannello di accesso a sgancio rapido o anta ad apertura verticale con tastiera per il controllo degli oli
- B** Comandi per l'estrazione dell'olio opzionali
- C** Bobine superiori per l'erogazione/estrazione dell'olio o dell'acqua
- D** Pannelli di manutenzione in acciaio inossidabile ad accesso rapido
- E** Sgocciolatoio di acciaio inossidabile rimovibile con tubo per la raccolta dell'olio opzionale
- F** Bobine inferiori per l'erogazione dell'aria con pannello di accesso a sgancio rapido
- G** Cilindri di metallo protettivi per le bobine
- H** Valvole di intercettazione integrate



Tall Fluid Management Cabinets

Armoires de gestion de fluides hautes
Schmale Schränke für Flüssigkeitsmanagement
Armadi alti per la gestione dei fluidi
Armarios altos de gestión de fluido
Grote Kasten voor Vloeistofbeheer

p51

Low Level Fluid Management Cabinets

Armoires de gestions des fluides basses
Niedrige Schränke für Flüssigkeitsmanagement
Armadi bassi per la gestione dei fluidi
Armarios de gestión de fluido de nivel bajo
Laag Niveau Kasten voor Vloeistofbeheer

p52

Gestión de fluido integrada

Soluciones flexibles y eficientes para gestionar el aceite, el aire y el agua, evitando derrames y mejorando la salud y la seguridad. Tres anchos modulares de 600, 900 y 1200mm.

El producto tiene las características siguientes:

- A** Panel de acceso de liberación rápida o puerta de apertura vertical con teclado de supervisión del aceite
- B** Controles opcionales de extracción de aceite
- C** Carretes superiores para la entrega/extracción de agua
- D** Paneles de mantenimiento de acceso rápido de acero inoxidable
- E** Bandeja de goteo de acero inoxidable retirables con tubo opcional de captura de aceite
- F** Carretes inferiores para suministro de aire con panel de acceso de liberación rápida
- G** Rodillos metálicos de protección para carretes
- H** Válvulas de cierre integradas

Geïntegreerd vloeistofbeheer

Flexibele en doeltreffende oplossingen voor het beheer van olie, lucht en water, vermijden morsen en zijn beter voor gezondheid en veiligheid. Drie modulaire breedtes: 600, 900 en 1200mm.

Technische kenmerken:

- A** Snel te openen paneel of verticale openingsdeur met toetsenbord voor oliebeheer
- B** Optionele bedieningsfuncties voor olie-afvoer
- C** Bovenrollen voor aanvoer/afvoer van olie of water
- D** Roestvrijstalen snel toegankelijke onderhoudspanelen
- E** Afneembare roestvrijstalen lekbak met optionele pijp voor oliewinning
- F** Onderrollen voor luchtaanvoer met snel te openen paneel
- G** Beschermende metalen rollers voor rollen
- H** Geïntegreerde afsluitkleppen





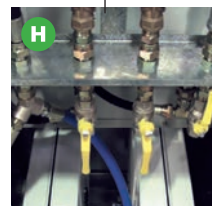



Optional three quarter or full height rear panels
 Panneaux arrière optionnels sur toute la hauteur ou aux trois quarts
 Dreiviertel Rückpaneele oder Rückpaneele über gesamte Höhe auf Wunsch
 Pannelli posteriori con altezza a tre quarti o completa opzionali
 Paneles posteriores opcionales de tres cuartos o altura total
 Optionele achterpanelen, driekwart hoog of volledige hoogte



Tall Fluid Management Cabinets

Armoires de gestion de fluides hautes
 Schmale Schränke für Flüssigkeitsmanagement
 Armadi alti per la gestione dei fluidi
 Armarios altos de gestión de fluido
 Grote Kasten voor Vloeistofbeheeronder werkbank

-  2m high fluid management cabinets which can be custom fitted with most air, oil, water and electrical facilities. Contain quick-release panels or a vertical door for integrated keypad. Removable drip-trays and adjustable feet **(reels and keypad not included)**.
-  Armoires de gestion de fluides, hauteur 2 m, personnalisables pour la plupart des installations d'air, d'huile, d'eau ou d'électricité. Comprend des panneaux ou une porte à ouverture rapide pour clavier intégré. Cuvettes d'égouttage amovibles et pieds réglables **(sans bobine, ni clavier)**.
-  2 m hohe Flüssigkeitsmanagement-Schränke; individuell anpassbar an die meisten gängigen Einrichtungen zum Luft-, Öl-, Wasser- und Elektrikmanagement. Enthält Schnellfreigabetafeln oder eine vertikale Tür für eine integrierte Tastatur. Abnehmbare Auffangwannen und einstellbare FüÙe **(Aufroller und Tastatur nicht enthalten)**.
-  Armadi per la gestione dei fluidi alti 2 m, personalizzabili con la maggior parte degli impianti per aria, olio, acqua ed elettricit . Contengono pannelli a sgancio rapido o un'anta verticale per tastiera integrata. Sgocciolatoio rimovibile e piedini regolabili **(bobine e tastiera non inclusi)**.
-  Armarios de gesti n de fluido de 2 m de altura que pueden personalizarse para adaptarse a la mayor a de instalaciones de aire, aceite, agua y el ctricas. Incluye paneles de liberaci n r pida o una puerta vertical para el teclado integrado. Bandejas de goteo extra bles y patas ajustables **(carretes y teclado no incluidos)**.
-  2 m hoge kasten voor vloeistofbeheer die op maat kunnen worden afgestemd op de meeste lucht-, olie-, water- en elektriciteitsvoorzieningen. Bevatten snel te openen panelen of een verticale deur voor een ge ntegreerd toetsenbord. Afneembare lekbakken en instelbare poten **(rollen en toetsenbord niet inbegrepen)**.



 Maximum number of reels / Nombre d'enroulements maximal / Maximale Anzahl an Aufrollern / Numero massimo di bobine / Cantidad m xima de carretes / Maximum aantal rollen

Low Level Fluid Management Cabinets

Armoires basses pour la gestion des fluides
 Niedrige Schränke für Flüssigkeitsmanagement
 Armadi bassi per la gestione dei fluidi
 Armarios bajos para la gestión de fluido
 Laag Niveau Kasten voor Vloeistofbeheer



-  950mm high fluid management cabinets which can be custom fitted with most air, oil, water or electrical reels. Contain removable drip-trays and adjustable feet. **Reels not included.**
-  Des armoires de gestion des fluides de 950mm de hauteur qui peuvent être aménagées sur mesure avec la plupart des enroulements d'air, d'huile, d'eau ou d'électricité. Dotées de bacs récepteurs amovibles et de pieds réglables. **Enrouleurs pas inclus.**
-  950mm hohe Schränke für Flüssigkeitsmanagement, die auf Kundenwunsch mit fast allen Luft-, Öl-, Wasser- oder Elektrivorrichtungen ausgestattet werden können. Mit abnehmbaren Auffangwannen und regelbaren Füßen. **Aufroller nicht eingeschlossen.**
-  Armadi per la gestione dei fluidi alti 950mm che si possono personalizzare con la maggior parte degli impianti per aria, olio, acqua ed elettricità. Contengono sgocciolatoio rimovibile e piedini regolabili. **Le bobine non sono incluse.**
-  Armarios de gestión de fluido de 950 mm de altura. Pueden personalizarse, para adaptarlos a la mayor parte de carretes de aire, aceite, agua y eléctricos. Contiene bandejas de goteo extraíbles y patas ajustables. **Los carretes no son incluidos.**
-  950mm hoge kasten voor vloeistofbeheer die op maat kunnen worden afgestemd op de meeste lucht-, olie-, water- en elektriciteitsrollen. Bevat afneembare lekbakken en instelbare poten. **Rollen niet inbegrepen.**



BXF-060
 H 950mm
 W 600mm
 D 600mm

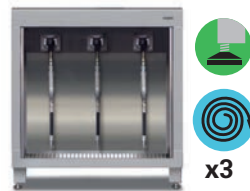

BXF-090
 H 950mm
 W 900mm
 D 600mm



BXF-120
 H 950mm
 W 1200mm
 D 600mm

Low Level Non-Fluid Management Cabinets

Armoires basses pour la gestion des non-fluides
 Niedrige Schränke für das Management von Nichtflüssigkeiten
 Armadi bassi per la gestione di non liquidi
 Armarios bajos para la gestión de no fluido
 Laag Niveau Kasten voor niet-vloeistofbeheer

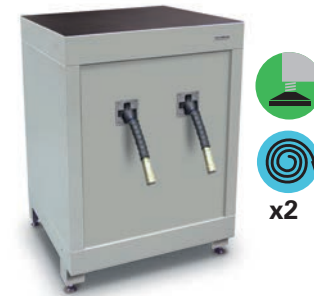

BU-023
 H 950mm, W 600mm, D 600mm



BU-032
 H 950mm, W 300mm, D 600mm

-  Low-level air & electrical management cabinets which can be custom fitted with up to two air or electrical reels. Contains adjustable feet.
-  Armoires basses pour enrouleurs de tuyau d'air comprimé ou de câble électrique, personnalisables avec deux enrouleurs de tuyau d'air comprimé ou de câble électrique. Prise pieds réglables.
-  Niedrige Schränke für Luft- und Elektrik-Aufroller-Management, Ausstattung mit bis zu zwei Luft- oder Elektrik-Aufrollern möglich. Mit einstellbaren Füßen.
-  Armadi bassi per la gestione degli impianti per aria ed elettricità, personalizzabili con un massimo di due bobine per aria o elettricità. Dispone piedini regolabili.
-  Armarios de gestión de carretes de aire de nivel bajo y eléctricos que pueden personalizarse con hasta dos carretes de aire o eléctricos. Incluye patas ajustables.
-  Lage kasten voor beheer van rollen voor lucht en elektriciteit die op maat kunnen worden uitgerust met maximaal twee rollen voor luchtleidingen of elektrische kabels. Met instelbare poten.
-  Narrow, low-level air & electrical management cabinets which can be custom fitted with up to two air or electrical reels, plus 2 'Commando' power sockets. Contains adjustable feet.
-  Armoires étroites basses pour enrouleurs de tuyau d'air comprimé ou de câble électrique, personnalisables avec deux enrouleurs de tuyau d'air comprimé ou de câble électrique, plus une 'Commando' prise de courant. Prise pieds réglables.
-  Schmale, niedrige Schränke für Luft- und Elektrik-Aufroller-Management, Ausstattung mit bis zu zwei Luft- oder Elektrik-Aufrollern möglich, sowie eine 'Commando'-Steckdose. Mit einstellbaren Füßen.
-  Armadi bassi e stretti per la gestione degli impianti per aria ed elettricità, personalizzabili con un massimo di due bobine per aria o elettricità, più una presa di corrente 'Commando'. Dispone piedini regolabili.
-  Armarios estrechos de gestión de carretes de aire de nivel bajo y eléctricos que pueden personalizarse con hasta dos carretes de aire o eléctricos, más un enchufe de 'Commando'. Incluye patas ajustables.
-  Smalle, lage kasten voor beheer van rollen voor lucht en elektriciteit die op maat kunnen worden uitgerust met maximaal twee rollen voor luchtleidingen of elektrische kabels, plus een 'Commando' stopcontact. Met instelbare poten.



Maximum number of reels
 Nombre d'enroulements maximal
 Maximale Anzahl an Aufrollern
 Numero massimo di bobine
 Cantidad máxima de carretes
 Maximum aantal rollen



Reels not included
Enrouleurs pas inclus
Aufroller nicht eingeschlossen
Le bobine non sono incluse
Los carretes no son incluidos
Rollen niet inbegrepen

General Storage Cabinets

Placards de rangement basique

Allgemeine Lagerschränke

Armadi bassi per lo stoccaggio generale

Armarios de base para almacenamiento general

Algemene onderkasten





1200mm base cabinets with doors

1200mm Placards de rangement avec portes
 1200mm Unterschränke mit Türen
 Armadi bassi da 1200 mm con ante
 Armarios de base de 1200 mm con puertas
 1200mm Onderkasten met Deuren

H 950mm, W 1200mm, D 600mm



 1200mm wide base cabinet, with hinged double doors and adjustable shelf. Available with feet or castors.

 Placard de rangement de 1200mm de large, avec portes doubles montées sur charnières et étagère ajustable. Disponible avec des pieds ou des roulettes.

 1200mm breiter Unterschrank, mit Flügeldoppeltür und verstellbarem Einlegeboden. Mit Füßen oder Rollen erhältlich.

 Armadio basso largo 1200mm, con ante doppie a battente e ripiano regolabile. Disponibile con piedini o ruote orientabili.

 Armario de base de 1200mm de ancho, con dos puertas bisagras y repisa ajustable. Disponible con patas o ruedas giratorias.

 Onderkast 1200mm breed met dubbele scharnierdeuren en verstelbare legplank. Leverbaar met poten of wielen.



 1200mm wide base cabinet, with sliding double doors and adjustable shelf. Available with feet or castors.

 Placard de rangement de 1200mm de large avec portes doubles coulissantes et étagère ajustable. Disponible avec des pieds ou des roulettes.

 1200mm breiter Unterschrank, mit Schiebedoppeltüren und verstellbarem Einlegeboden. Mit Füßen oder Rollen erhältlich.

 Armadio basso largo 1200mm, con ante doppie scorrevoli e ripiano regolabile. Disponibile con piedini o ruote orientabili.

 Armario de base de 1200mm de ancho, con dos puertas de correr y repisa ajustable. Disponible con patas o ruedas giratorias.

 Onderkast 1200mm breed met dubbele schuifdeuren en verstelbare legplank. Leverbaar met poten of wielen.

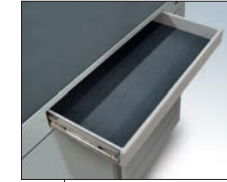

 1200mm wide base cabinet, with hinged double doors, a drawer and an adjustable shelf. Contains adjustable feet.

 Placard de rangement de 1200mm de large, avec portes doubles montées sur charnières, un tiroir, et étagère ajustable. Prise pieds réglables.

 1200mm breiter Unterschrank, mit Flügeldoppeltür, einer Schublade und verstellbarem Einlegeboden. Mit einstellbaren Füßen.

 Armadio basso largo 1200mm, con ante doppie a battente, un cassetto, e ripiano regolabile. Dispone piedini regolabili.

 Armario de base de 1200mm de ancho, con dos puertas bisagras, un cajón, y repisa ajustable. Incluye patas ajustables.

 Onderkast 1200mm breed met dubbele scharnierdeuren, een lade en verstelbare legplank. Met instelbare poten.





900mm base cabinets with doors

900mm Placards de rangement avec portes
 900mm Unterschänke mit Türen
 Armadi bassi da 900 mm con ante
 Armarios de base de 900 mm con puertas
 900mm Onderkasten met Deuren

H 950mm, W 900mm, D 600mm



 900mm wide base cabinet, with hinged double doors and adjustable shelf. Available with feet or castors.

 Placard de rangement de 900mm de large, avec portes doubles montées sur charnières et étagère ajustable. Disponible avec des pieds ou des roulettes.

 900mm breiter Unterschrank, mit Flügeldoppeltür und verstellbarem Einlegeboden. Mit Füßen oder Rollen erhältlich.

 Armadio basso largo 900mm, con ante doppie a battente e ripiano regolabile. Disponibile con piedini o ruote orientabili.

 Armario de base de 900mm de ancho, con dos puertas bisagras y repisa ajustable. Disponible con patas o ruedas giratorias.

 Onderkast 900mm breed met dubbele scharnierdeuren en verstelbare legplank. Leverbaar met poten of wielen.



 900mm wide base cabinet, with sliding double doors and adjustable shelf. Available with feet or castors.

 Placard de rangement de 900mm de large avec portes doubles coulissantes et étagère ajustable. Disponible avec des pieds ou des roulettes.

 900mm breiter Unterschrank, mit Schiebedoppeltüren und verstellbarem Einlegeboden. Mit Füßen oder Rollen erhältlich.

 Armadio basso largo 900mm, con ante doppie scorrevoli e ripiano regolabile. Disponibile con piedini o ruote orientabili.

 Armario de base de 900mm de ancho, con dos puertas de correr y repisa ajustable. Disponible con patas o ruedas giratorias.

 Onderkast 900mm breed met dubbele schuifdeuren en verstelbare legplank. Leverbaar met poten of wielen.

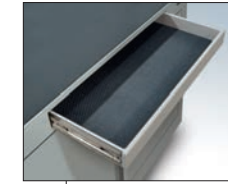



 900mm wide base cabinet, with hinged double doors, a drawer and an adjustable shelf. Contains adjustable feet.

 Placard de rangement de 900mm de large, avec portes doubles montées sur charnières, un tiroir, et étagère ajustable. Prise pieds réglables.

 900mm breiter Unterschrank, mit Flügeldoppeltür, einer Schublade und verstellbarem Einlegeboden. Mit einstellbaren Füßen.

 Armadio basso largo 900mm, con ante doppie a battente, un cassetto, e ripiano regolabile. Dispone piedini regolabili.

 Armario de base de 900mm de ancho, con dos puertas bisagras, un cajón, y repisa ajustable. Incluye patas ajustables.

 Onderkast 900mm breed met dubbele scharnierdeuren, een lade en verstelbare legplank. Met instelbare poten.



600mm base cabinets with doors

600mm Placards de rangement avec portes
 600mm Unterschränke mit Türen
 Armadi bassi da 600 mm con ante
 Armarios de base de 600 mm con puertas
 600mm Onderkasten met Deuren

H 950mm, W 600mm, D 600mm



- 600mm wide base cabinet with hinged door and adjustable feet or lockable castors. Includes adjustable shelf.
- Placard de rangement de 600mm de large avec porte montée sur charnières. Disponible avec des pieds ou des roulettes. Comprend une étagère intérieure ajustable.
- 600mm breiter Unterschrank, mit Flügeltür. Mit Füßen oder Rollen erhältlich. Inklusive verstellbarem Einlegeboden.
- Armadio basso largo 600mm con anta a battente. Disponibile con piedini o ruote orientabili. Comprende e regolabile ripiano interno.
- Armario de base de 600mm de ancho, con puerta bisagras. Disponible con patas o ruedas giratorias. Incluye repisa interna ajustable.
- Onderkast 600mm breed met een scharnierende deur. Leverbaar met poten of wielen. Omvat verstelbare legplank.

- 600mm wide base cabinet with 2 x hinged doors and adjustable feet or lockable castors.
- Placard de rangement avec 2 portes. Disponible avec des pieds ou des roulettes.
- 600mm breiter Unterschrank, mit 2 Türen. Mit Füßen oder Rollen erhältlich.
- Armadio basso largo 600mm con 2 portelli. Disponibile con piedini o ruote orientabili.
- Armario de base de 600mm de ancho, con 2 puertas. Disponible con patas o ruedas giratorias.
- Onderkast 600mm breed met 2 deuren. Leverbaar met poten of wielen.

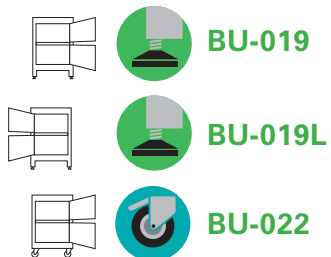
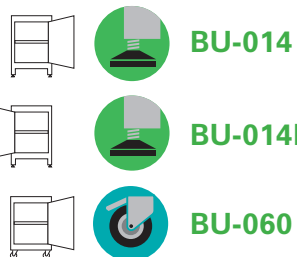

- 600mm wide base cabinet with hinged door and 3 medium drawers. Adjustable feet or lockable castors.
- Meuble de rangement de base, largeur 600mm, avec 3 tiroirs et une porte. Disponible avec des pieds ou des roulettes.
- 600mm breiter Unterschrank mit 3 Schubladen und 1 Tür. Mit Füßen oder Rollen erhältlich.
- Armadio basso largo 600mm con 3 cassetti e 1 porta. Disponibile con piedini o ruote orientabili.
- Armario de base de 600mm de ancho con 3 cajones y puerta bisagras. Disponible con patas o ruedas giratorias.
- Onderkast 600mm breed met 3 laden en 1 deur. Leverbaar met poten of wielen.

- 600mm wide base cabinet, with towel and glove dispenser drawer and door.
- Meuble de rangement de base, largeur 600mm, équipé d'une porte et d'un tiroir avec distributeurs de serviettes et de gants intégrés.
- 600mm breiter Unterschrank mit Schublade und Tür für Handtuch- und Handschuhspender.
- Armadio basso largo 600mm con cassetto e sportello, comprende un supporto per guanti e rotoli asciugamani.
- Armario de base de 600mm de ancho, con puerta y cajón para dispensador de guantes y toallas.
- Onderkast 600mm breed, met handdoeken- handschoendispenserlade en deur.



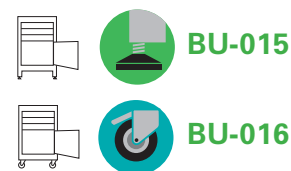

<p>Drawer external depths Hauteur du tiroir, externe Schubladenhöhe - außen Altezza cassetto - esterna Altura del cajón - externa Hoogte lade - buitenkant</p>	 <p>85mm x3</p>
<p>Drawer internal dimensions Dimensions du tiroir, interne Abmessungen der Schubladen - innen Dimensioni cassetti - interne Dimensiones del cajón - internas Afmetingen lade - binnenkant</p>	<p>H 71mm W 468mm D 575mm</p> <p>MAX 65kg UDL</p>



600mm base cabinets with drawers

600mm Placards de rangement avec tiroirs
 600mm Unterschranke mit Schubladen
 Armadi bassi con cassetti da 600 mm
 Armarios de base con cajones de 600 mm
 600mm Onderkasten met laden

H 950mm, W 600mm, D 600mm

Drawer external depths			
Hauteur du tiroir, externe Schubladenhöhe - außen Altezza cassetto - esterna Altura del cajón - externa Hoogte lade - buitenkant			
		85mm	180mm
Drawer internal dimensions			
Dimensions du tiroir, interne Abmessungen der Schubladen - innen Dimensioni cassetti - interne Dimensiones del cajón - internas Afmetingen lade - binnenkant			
H 71mm	H 164mm	W 468mm	W 468mm
D 575mm	D 575mm		



-  600mm wide base cabinet with 3 medium drawers + 1 extra deep drawer. Adjustable feet.
-  Meuble de rangement de base, largeur 600 mm, avec 3 tiroirs et une tiroir extra profond. Disponible avec des pieds.
-  600 mm breiter Unterschrank mit 3 Schubladen und 1 extratiefen Schublade. Mit Füßen.
-  Armadio basso largo 600mm con 3 cassetti e 1 cassetto extra profondo. Disponibile con piedini.
-  Armario de base de 600mm de ancho con 3 cajones y 1 cajón extra profundo. Disponible con patas.
-  Onderkast 600mm breed met 3 laden en 1 extra diepe lade. Leverbaar met poten.





-  600mm wide base cabinet with 5 drawers. With adjustable feet or lockable castors.
-  Meuble de rangement de base, largeur 600 mm, avec 5 tiroirs. Disponible avec des pieds ou des roulettes
-  600 mm breiter Unterschrank mit 5 Schubladen. Mit Füßen oder Rollen erhältlich.
-  Armadio basso largo 600mm con 5 cassetti. Disponibile con piedini o ruote orientabili.
-  Armario de base de 600mm de ancho con 5 cajones. Disponible con patas o ruedas giratorias.
-  Onderkast 600mm breed met 5 laden. Leverbaar met poten of wielen.



-  600mm wide base cabinet with 7 drawers. With adjustable feet or lockable castors.
-  Meuble de rangement de base, largeur 600 mm, avec 7 tiroirs. Disponible avec des pieds ou des roulettes
-  600 mm breiter Unterschrank mit 7 Schubladen. Mit Füßen oder Rollen erhältlich.
-  Armadio basso largo 600mm con 7 cassetti. Disponibile con piedini o ruote orientabili.
-  Armario de base de 600mm de ancho con 7 cajones. Disponible con patas o ruedas giratorias.
-  Onderkast 600mm breed met 7 laden. Leverbaar met poten of wielen.



Heavy-duty 600mm Tool Storage Cabinets

-  600mm Meubles de rangement é Haute-résistance pour outils
-  600mm Werkzeugschränke für Schwere Gegenstände
-  Armadi per impieghi gravosi da 600 mm per lo stoccaggio degli utensili
-  Armarios de alto rendimiento de almacenamiento de herramientas de 600 mm
-  600mm Zwaar uitgevoerde opbergkasten voor gereedschap

p18-19



-  **300mm wide base cabinet with hinged door and adjustable feet.**
-  Placard de rangement de 300mm de large avec porte montée sur charnières et pieds ajustables,
-  300mm breiter Unterschrank, mit Flügeltür und verstellbaren Füßen.
-  Armadio basso largo 300mm con anta a battente e ripiano regolabile.
-  Armario de base de 300mm de ancho, con puerta bisagras y patas ajustables.
-  Onderkast 300mm breed met dubbele scharnierdeuren en verstelbare poten.



2m High heavy-duty shelving

Étagères à Haute-résistance
Regale für schwere Gegenstände
Ripiani resistenti
Repisas de alto rendimiento
Zware legplanken

-  2m high units available in 300mm or 600mm depths with 4 adjustable shelves, also available with doors.
These units should be fixed securely to a wall.
-  Unités de 2 m de haut disponibles dans des profondeurs de 300mm ou 600mm avec 4 étagères ajustables, également disponibles avec des portes.
Ces unités doivent être fixées au mur de manière sécurisée.
-  2m hohe Einheiten, erhältlich in 300mm oder 600mm Tiefe mit 4 verstellbaren Einlegeböden.
Diese Einheiten sollten sicher an einer Wand befestigt werden.
-  Unità alte 2m disponibili con una profondità di 300mm o 600mm con 4 ripiani regolabili, disponibili anche con ante.
Queste unità devono essere fissate bene al muro.
-  Las unidades de 2 m de altura están disponibles en profundidades de 300mm o 600mm con 4 repisas ajustables y también con puertas.
Estas unidades deben ser fijadas con seguridad a una pared.
-  2m hoge units leverbaar 300mm of 600mm breed en 4 verstelbare legplanken, tevens beschikbaar met deuren.
Deze units stevig aan de wand bevestigen.



4 shelves

RS-060
W 1200mm D 600mm

RS-030
W 1200mm D 300mm

RS-090
W 900mm D 600mm



4 shelves + doors

RS-062
W 1200mm D 600mm

RS-032
W 1200mm D 300mm

RS-092
W 900mm D 600mm

RS-093
W 900mm D 300mm



Peg panel + 2 shelves

RSP-063
W 1200mm D 600mm

RSP-093
W 900mm D 600mm

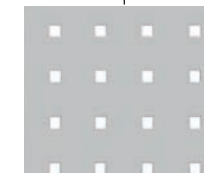

Peg panels

Panneaux perforés – panneaux munis de trous carrés pour un système de crochets.

Lochplatten – Paneele mit quadratischen Löchern für Hakensysteme.

Pannelli forati – Pannelli forati quadrati per sistema a ganci.

Paneles perforados - Paneles con agujeros cuadrados para un sistema de enganche.

Geperforeerde panelen - Panelen met vierkanten gaten voor haaksysteem.



Hybrid panel + doors

RSH-1260
W 1200mm D 600mm

RSH-1230
W 1200mm D 300mm

RSH-960
W 900mm D 600mm

RSH-930
W 900mm D 300mm

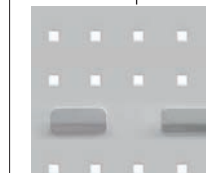

Hybrid panels

Hybrid panels – with louvre and peg.

Panneaux hybrides – avec claire-voie et perforation.

Hybridpaneel – mit Lüftungsöffnungen und quadratischen Löchern für Hakensysteme.

Pannelli ibridi – con pannelli a stecche verticali e pannelli forati.

Paneles híbridos – de cortina y perforados.

Hybride panelen – met louvre en gaten.

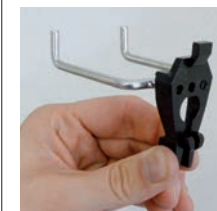

Accessories for panels

Accessoires pour panneaux
Zubehör für Paneele
Accessori per pannelli
Accesorios para paneles
Accessoires voor panelen

p114-117



2m High heavy-duty shelving with drawers

Unité en Haute-résistance avec 4 tiroirs et étagère
 Schrank mit Schubladen und Regal
 Armadio resistenti con cassetti e ripiano
 Armario de alto rendimiento con cajones y estante
 Zware kast met lades en plank

- 2m high units available in 900mm or 1200mm widths. Includes drawers, an adjustable shelf, and square peg panels on the inner sides and doors. Can be fitted with rear hybrid panel.
- Unités de 2 m de haut disponibles en largeurs de 900 mm ou 1200 mm. Comprend des tiroirs, une étagère réglable et des panneaux perforés sur les côtés intérieurs et les portes. Peut être équipé d'un panneau arrière hybride.
- 2 m hohe Einheiten in 900 mm oder 1200 mm Breite erhältlich. Enthält Schubladen, ein verstellbares Einlegeböden und Lochplatten an Innenseiten und Türen. Kann mit einer Hybrid-Rückwand ausgestattet werden.
- Unità alte 2m disponibili in larghezze 900mm o 1200mm. Include cassetti, un ripiano regolabile e pannelli forati sui lati interni e sulle porte. Può essere dotato di pannello ibrido posteriore.
- Las unidades de 2 m de altura disponibles en anchos de 900 mm o 1200 mm. Incluye cajones, un estante ajustable y paneles perforados en los lados interiores y puertas. Puede equiparse con panel trasero híbrido.
- 2m hoge units beschikbaar in breedtes van 900mm of 1200mm. Inclusief lades, een verstelbare plank en geperforeerde panelen aan de binnenzijden en deuren. Kan worden gemonteerd met hybride achterpaneel.

Accessories for RSR cabinets

Accessoires pour armoires RSR
 Zubehör für RSR-Schränke
 Accessori per armadi RSR
 Accesorios para armarios RSR
 Accessoires voor RSR-kasten



Rear hybrid panel
 Panneau arrière hybride
 Hybrid-Rückwand
 Pannello ibrido posteriore
 Panel trasero híbrido
 Hybride achterpaneel

HBR-090 900mm
HBR-120 1200mm



Electrical socket panel
 Panneau de prises de électriques
 Steckdosenleiste
 Pannello delle prese di corrente
 Panel de enchufes de alimentación
 Stopcontact paneel

UKP-001 UK
EUROP-001 Euro



Additional shelf
 Étagère supplémentaire
 Zusätzliches Regal
 Ripiano supplementare
 Estante adicional
 Extra legplank

SHR-090 900mm
SHR-120 1200mm



Hanging rail
 Rail suspendu
 Hängeschiene
 Asta appendiabiti
 Riel colgante
 Hangende rail

CRR-090 900mm
CRR-120 1200mm



900mm width

Drawer external depths

Hauteur du tiroir, externe
 Schubladenhöhe - außen
 Altezza cassetto - esterna
 Altura del cajón - externa
 Hoogte lade - buitenkant



82mm



172mm



Drawer internal dimensions

Dimensions du tiroir, interne
 Abmessungen der Schubladen - innen
 Dimensioni cassetti - interne
 Dimensiones del cajón - internas
 Afmetingen lade - binnenkant

H 73mm
 W 652mm
 D 487mm



MAX 75kg UDL

H 163mm
 W 652mm
 D 487mm



MAX 150kg UDL

RSR-904



1

3

RSR-905



3

2

RSR-906



5

1

RSR-907



7



1200mm width

Drawer external depths

Hauteur du tiroir, externe
 Schubladenhöhe - außen
 Altezza cassetto - esterna
 Altura del cajón - externa
 Hoogte lade - buitenkant



82mm



172mm



Drawer internal dimensions

Dimensions du tiroir, interne
 Abmessungen der Schubladen - innen
 Dimensioni cassetti - interne
 Dimensiones del cajón - internas
 Afmetingen lade - binnenkant

H 73mm
 W 952mm
 D 487mm



MAX 75kg UDL

H 163mm
 W 952mm
 D 487mm



MAX 150kg UDL

RSR-040



1

3

RSR-050



3

2

RSR-060



5

1

RSR-070



7



Utility storage cabinets

Ravitaillieur/meuble de rangement
Zapfsäulen/ Mehrzweckschrank
Armadio per lo stoccaggio di cisterne/attrezzature
Armario de almacenamiento de bomba/auxiliares
Tankwagen/opbergkast

Utility storage cabinet, with double doors. Designed to store floorstanding items. Includes adjustable feet. Can store item within maximum dimensions of *

Ravitaillieur/meuble de rangement, avec portes doubles. Pour le rangement d'équipement reposant au sol. Pieds réglables. Possibilité de ranger des objets de dimensions maximales de *

Zapfsäulen/Mehrzweckschrank mit Doppeltüren. Zur Aufbewahrung von stehenden Artikeln konzipiert. Einschließlich einstellbarer Füße. Kann Gegenstände bis zu einer maximalen Größe von * lagern.

Armadio per lo stoccaggio di cisterne/attrezzature, con ante doppie. Progettati per contenere elementi da pavimento. Include dei piedini regolabili. Può stoccare oggetti di dimensioni massime *

Armario de almacenamiento de bomba/auxiliares, con dos puertas. Diseñado para almacenar elementos apoyados en el suelo. Incluye patas ajustables. Puede almacenar un artículo de dimensiones máximas de *

Tankwagen/opbergkast, met dubbele deuren. Ontworpen om op de vloer staande voorwerpen op te bergen. Inclusief verstelbare poten. Voor opslag van voorwerpen met max. afmetingen *

BST Base trays

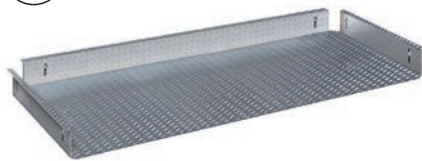

Optional base trays, to add to utility storage cabinets for additional stability when installed without adjacent base cabinets.

Plateaux de base en option, ajoutée pour une stabilité supplémentaire en l'absence d'armoires au sol contiguës.

Optionale Grundschaalen, die den Mehrzweckschrank für zusätzliche Stabilität hinzugefügt werden können bei Installation ohne angrenzende Unterschränke.

Vassoi di base opzionali, da aggiungere agli armadietti per una maggiore stabilità se installati senza armadietti di base adiacenti.

Bandejas de base opcionales, para aportar una mayor estabilidad cuando la instalación se realiza sin armarios de base adyacentes.

Optionele bodembakken, voor extra stabiliteit indien geïnstalleerd zonder aangrenzende onderkasten.



2000mm height

Includes adjustable shelf.
Comprend une étagère intérieure ajustable.
Inklusive und verstellbaren Einlegeboden.
Comprende e regolabile ripiano interno.
Incluye repisa interna ajustable.
Omvat verstelbare legplank.

Maximum capacity.
Capacité maximale.
Maximale Kapazität.
Capacità massima.
Maxima capacidad
Maximale capaciteit.

Base tray
Plateaux de base
Grundschaalen
Vassoi di base
Bandejas de base
Bodembakken

BUES-123 W 1200 D 900mm *H 1850 W 1040 D 860mm*

BUES-124 W 1200 D 750mm *H 1850 W 1040 D 710mm*

CUES-120 W 1200 D 600mm *H 1850 W 1040 D 560mm*

BUES-091 W 900 D 900mm *H 1850 W 740 D 860mm*

BUES-093 W 900 D 750mm *H 1850 W 740 D 710mm*

CUES-090 W 900 D 600mm *H 1850 W 740 D 560mm*

BST-1290

BST-1275

BST-1260

BST-0990

BST-0975

BST-0960



1395mm height

BUES-151 W 1500 D 750mm *H 1230 W 1340 D 560mm*

BUES-122 W 1200 D 900mm *H 1230 W 1040 D 860mm*

BUES-125 W 1200 D 750mm *H 1230 W 1040 D 710mm*

BUES-092 W 900 D 900mm *H 1230 W 740 D 860mm*

BUES-095 W 900 D 750mm *H 1230 W 740 D 710mm*

Maximum capacity.
Capacité maximale.
Maximale Kapazität.
Capacità massima.
Maxima capacidad
Maximale capaciteit.

BST-1575

BST-1290

BST-1275

BST-0990

BST-0975



950mm height

BUES-120 W 1200 D 600mm *H 790 W 1040 D 560mm*

BUES-090 W 900 D 600mm *H 790 W 740 D 560mm*

BUES-061 W 600 D 600mm *H 790 W 440 D 560mm*

Maximum capacity.
Capacité maximale.
Maximale Kapazität.
Capacità massima.
Maxima capacidad
Maximale capaciteit.

BST-1260

BST-0960

BST-0660



Tall base cabinets

Armoires de rangement hautes
Schmale Schränke
Armadi alti
Armarios altos
Hoge kasten

-  Tall base cabinet with inner adjustable shelf and adjustable feet. 2-point locking door.
*Available in 600 or 400mm depth.
-  Armoire de rangement haute avec étagère ajustable intérieure et pieds ajustables. Porte verrouillable.
*Disponible en 600 ou 400mm de profondeur.
-  Schmäler Schrank mit verstellbarem Einlegeboden und regelbaren Füßen. Tür mit 2-Punkt Verriegelung.
*Mit 600 oder 400mm Tiefe erhältlich.
-  Armadio alto con ripiano interno regolabile e piedini regolabili. Anta bloccabile in 2 punti.
*Disponibile con una profondità da 600 o 400mm.
-  Armario de base alto con repisa interior y patas ajustables. Puerta cierre con llave 2 puntos.
*Disponible en 600 o 400mm de profundidad.
-  Hoge onderkast met verstelbare legplank en verstelbare poten. Deur met tweepuntssluiting.
*Leverbaar in 600 of 400mm diep.

	CU-006 H 2000mm W 600mm D 600mm	CU-007 H 2000mm W 600mm D 400mm
---	---	---

	CU-006L H 2000mm W 600mm D 600mm	CU-007L H 2000mm W 600mm D 400mm
---	--	--



-  600mm wide tall cabinet with two independent lockers, each with adjustable shelf. Adjustable feet.
-  Armoire de rangement haute de 600mm de large avec 2 casiers indépendants, tous deux avec une étagère ajustable. Pieds ajustables.
-  Schmäler Schrank mit 600mm Breite und zwei unabhängigen verschließbaren Fächern, jedes davon mit einem verstellbaren Einlegeboden. Regelbare Füße.
-  Armadio alto largo 600mm con due scomparti indipendenti, ciascuno con un ripiano regolabile. Piedini regolabili.
-  Armario alto de 600mm de ancho con dos compartimentos independientes, cada uno con repisa ajustable. Patas ajustables.
-  Hoge kast 600mm breed met twee onafhankelijke kastdelen, ieder met verstelbare legplank. Verstelbare poten.

	CU-009 H 2000mm W 600mm D 600mm
---	---

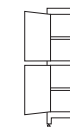
	CU-009L H 2000mm W 600mm D 600mm
---	--



-  600mm wide tall cabinet with four independent lockers. Adjustable feet.
-  Armoire de rangement haute de 600mm de large avec quatre casiers indépendants. Pieds ajustables.
-  Schmäler Schrank mit 600mm Breite und vier unabhängigen verschließbaren Fächern. Regelbare Füße.
-  Armadio alto largo 600mm con quattro scomparti indipendenti. Piedini regolabili.
-  Armario alto de 600mm de ancho con cuatro compartimentos independientes. Patas ajustables.
-  Hoge kast 600mm breed met vier onafhankelijke kastdelen. Verstelbare poten.

	CU-064 H 2000mm W 600mm D 600mm
---	---







	CU-064L H 2000mm W 600mm D 600mm
---	--



Tambour door cabinets

Armoire à rideau
Rolltürschrank
Armadio con porta
Armario de puerta de tambor
Jaloeziekast



-  2m high units with 'tambour' roller shutter door. Lockable, with 4 adjustable shelves and adjustable feet. These units should be fixed securely to a wall.
-  Modules de 2m de haut à porte à volet roulant. Verrouillable, dotée de 4 tablettes ajustables et de pieds réglables. Ces modules doivent être solidement fixés au mur.
-  2m hohe Einheit mit Rollenblendenverschlusstür. Blockierbar, mit 4 verstellbaren Einlegeböden und regelbaren Füßen. Diese Einheiten sollten sicher an einer Wand befestigt werden.
-  Unità alte 2m con porta con anta a cilindro a 'tamburo'. Chiudibile a chiave, con 4 ripiani regolabili e piedini anch'essi regolabili. Queste unità devono essere fissate bene a una parete.
-  Unidades de 2 m de altura con puerta de cierre de rodillo 'tambor'. Bloqueable, con 4 repisas ajustables y pies ajustables. Estas unidades deben fijarse con seguridad a un muro.
-  2m hoge units met 'jaloezie' roller schuifdeur. Vergrendelbaar, met 4 instelbare legplanken en instelbare poten. Deze units moeten stevig aan de wand worden bevestigd.

RSS-060 H 2000, W 600, D 600mm

RSS-090 H 2000, W 900, D 600mm







RSS-120 H 2000, W 1200, D 600mm

RSS-099 H 2000, W 900, D 900mm

Tambour door utility cabinets

Ravitailleur/meuble de rangement, fermeture à rideau.
Zapfsäulen/ Mehrzweckschrank mit Rollenblendenverschlusstür
Armadio per lo stoccaggio di cisterne/attrezzature con anta avvolgibile a "tamburo"
Armario de almacenamiento de bomba/auxiliares con cierre de rodillo «tambor»
Tankwagen/opbergkast met 'jaloezie'-schuifdeur.



-  2m high utility cabinet with 'tambour' roller shutter door. Designed to store floorstanding items. Includes adjustable feet.
-  Armoire de rangement, hauteur 2 m, fermeture à rideau. Pour le rangement d'équipement reposant au sol. Pieds réglables.
-  2 m hoher Versorgungsschrank mit Rollenblendenverschlusstür. Zur Aufbewahrung von stehenden Artikeln konzipiert. Einschließlich einstellbarer Füße.
-  Armadi per lo stoccaggio di attrezzature alti 2 m con anta avvolgibile a "tamburo". Progettati per contenere elementi da pavimento. Include dei piedini regolabili.
-  Armario de almacenamiento de 2 m de altura con puerta con cierre de rodillo «tambor». Diseñado para almacenar elementos apoyados en el suelo. Incluye patas ajustables.
-  2 m hoge opbergkast met 'jaloezie'-schuifdeur. Ontworpen om op de vloer staande voorwerpen op te bergen. Inclusief verstelbare poten.

BUES-060 H 2000, W 600, D 600mm

BUES-096 H 2000, W 900, D 600mm

BUES-126 H 2000, W 1200, D 600mm

BUES-150 H 2000, W 1500, D 900mm

BST Base trays

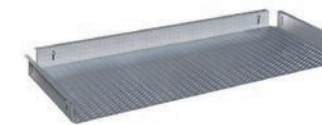

Optional base trays, to add to utility storage cabinets for additional stability when installed without adjacent base cabinets.

Plateaux de base en option, ajoutée pour une stabilité supplémentaire en l'absence d'armoires au sol contiguës.

Optionale Grundschaalen, die den Mehrzweckschrank für zusätzliche Stabilität hinzugefügt werden können bei Installation ohne angrenzende Unterschränke.

Vassoi di base opzionali, da aggiungere agli armadietti per una maggiore stabilità se installati senza armadietti di base adiacenti.

Bandejas de base opcionales, para aportar una mayor estabilidad cuando la instalación se realiza sin armarios de base adyacentes.

Optionele bodembakken, voor extra stabiliteit indien geïnstalleerd zonder aangrenzende onderkasten.

BST-0660
for BUES-060

BST-0960
for BUES-096

BST-1260
for BUES-126

BST-1590
for BUES-150

Cabinet Range for the Control of Substances Hazardous to Health (COSHH)

Gamme d'armoires pour le contrôle des substances dangereuses pour la santé
Schränke für die Aufbewahrung von gesundheitsgefährdenden Stoffen
Gamma di armadi per il controllo di sostanze pericolose per la salute
Gama de armarios para el control de sustancias peligrosas para la salud
Kastenprogramma voor de controle van stoffen die gevaarlijk zijn voor de gezondheid

UK Dura have created a range of cabinets for compliance with COSHH regulations, offering a choice of size and position for clearly identifiable storage points, that fit perfectly with the rest of our award-winning 600 Series cabinet range. Central to the design is a spillage capture facility, which is essential when handling hazardous liquids.

Special COSHH cabinet features:

- A** Adjustable shelves with draining holes and retaining lip
- B** Liquid-tight sump within the base
- C** Yellow epoxy coating to identify use clearly

Please call for further details.

FR Dura a créé une gamme d'armoires conformes à la réglementation en matière de santé et de sécurité, offrant un choix de tailles et de positions pour des points de stockage clairement identifiables, qui s'intègrent parfaitement au reste de notre gamme d'armoires primées de la série 600. Sa conception est centrée autour d'une installation de collecte des déversements, essentielle lors de la manipulation de liquides dangereux.

Caractéristiques spéciales de l'armoire:

- A** Étagères réglables avec orifices d'évacuation et rebord de retenue
- B** Bac étanche à l'intérieur de la base
- C** Revêtement époxy jaune pour une identification claire de l'utilisation

Veillez appeler pour plus de détails.

DE Dura hat zu diesem Zweck eine Produktreihe entwickelt, die den einschlägigen Vorschriften zur Kontrolle gesundheitsgefährdender Stoffe entspricht. Die Schränke in verschiedenen Größen und Aufstelloptionen für klar identifizierbare Lagerorte ergänzen unsere preisgekrönten Schränke der 600er Produktreihe perfekt. Ein zentrales Merkmal der Schränke und wesentlich für die Handhabung von gefährlichen Flüssigkeiten sind die Vorrichtungen zum Auffangen von Leckagen.

Besondere Merkmale der Gefahrstoffschränke:

- A** Verstellbare Böden mit Ablauflöchern und Überlaufschutz
- B** Flüssigkeitsdichte Aufwange am Boden
- C** Gelbe Epoxidbeschichtung zur eindeutigen Kennzeichnung der Verwendung

Bitte rufen Sie uns für weitere Details an.

IT Dura ha creato una gamma di armadi conformi alle normative in materia di salute e sicurezza, offrendo una scelta di dimensioni e posizioni per punti di stoccaggio chiaramente identificabili, che si integrano perfettamente con il resto della nostra pluripremiata linea di armadi della serie 600. Il suo design è incentrato su un impianto di raccolta delle fuoriuscite, essenziale quando si maneggiano liquidi pericolosi.

Particolarità degli armadi:

- A** Ripiani regolabili con fori di drenaggio e bordo di contenimento
- B** Pozzo di scarico a tenuta di liquidi sul pavimento
- C** Rivestimento epossidico giallo per una chiara identificazione dell'uso

Si prega di chiamare per ulteriori dettagli

ES Dura ha creado una gama de gabinetes que cumplen con las normas de salud y seguridad, ofreciendo una variedad de tamaños y posiciones para puntos de almacenamiento claramente identificables, que se integran a la perfección con el resto de nuestra galardonada línea de gabinetes Serie 600. Su diseño se centra en una instalación de recolección de derrames, esencial cuando se manejan líquidos peligrosos.

Características especiales de los armarios

- A** Estantes ajustables con orificios de drenaje y borde de retención
- B** Recipiente estanco dentro de la base
- C** Recubrimiento epoxi amarillo para una clara identificación de uso

Llame para obtener más detalles.

NL Dura heeft een serie kasten ontworpen die voldoen aan de regelgeving, met een keuze van formaten en plaatsingsmogelijkheden voor duidelijk herkenbare opslagpunten, die perfect passen binnen ons bekroond 600-kastenprogramma. Centraal onderdeel van het ontwerp is een voorziening voor de opvang van lekkende stoffen, wat cruciaal is voor de omgang met gevaarlijke vloeistoffen.

Speciale eigenschappen van kasten:

- A** Instelbare legborden met afvoergaten en opstaande rand
- B** Vloeistofdichte opvangbak onderaan
- C** Gele epoxycoating voor duidelijk herkenbaar gebruik

Bel voor meer informatie.



COSHH-092 H 2000, W 900, D 600mm

- UK** 2m high heavy-duty shelving with 4 adjustable shelves.
- FR** Unités de 2 m de haut avec 4 étagères ajustables.
- DE** 2m hohe Einheiten mit 4 verstellbare Einlegeböden.
- IT** Unità alte 2m con 4 ripiani regolabili.
- ES** Las unidades de 2m con 4 repisas ajustables.
- NL** 2m hoge units met 4 verstellbare legplanken.

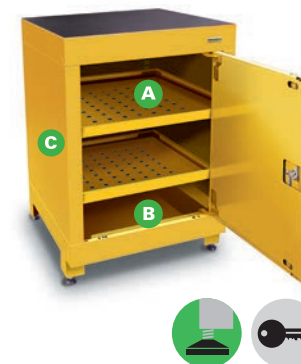
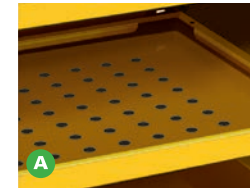

COSHH-014/014L H 950, W 600, D 600mm

- UK** Base cabinet with hinged door and 2 adjustable shelves.
- FR** Placard de rangement avec 2 étagères ajustables.
- DE** Unterschrank, mit 2 verstellbare Einlegeböden.
- IT** Armadio basso con 2 ripiani regolabili.
- ES** Armario de base con 2 repisas ajustables.
- NL** Onderkast met 2 verstellbare legplanken.



COSHH-014



COSHH-014L

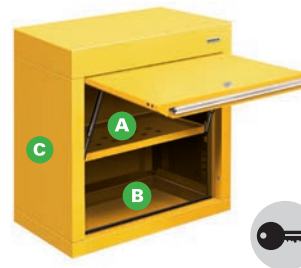

COSHH-060 H 600, W 600, D 300mm

- UK** Wall cabinet with lockable vertical door on gas struts and adjustable inner shelf.
- FR** Armoire avec porte verticale verrouillable sur amortisseurs à gaz et étagère intérieure ajustable.
- DE** Wandschrank mit verschließbarer vertikaler Tür auf Gasdruckfedern und verstellbarem Einlegebode
- IT** Armadio a muro con anta verticale chiudibile a chiave con puntoni a gas e ripiano interno regolabile.
- ES** Armario de muro con puerta vertical cerrada con llave soportada por cilindros de gas y repisa interior ajustable.
- NL** Kast met afsluitbare verticale deur met gasgevulde veerpoten en verstellbare legplank.

Specialised Base Cabinets

Placards de rangements spécialisés

Spezielle Unterschränke

Armadi bassi per lo stoccaggio specializzato

Armarios de base para almacenamiento especializado

Speciale onderkasten



600mm Wastebin Cabinets

600mm Rangements pour poubelle
600mm Schränke für Abfallbehälter
Armadi per pattumiera larghe 600mm
Armarios para basura de 600 mm de ancho
600mm Kasten met afvalbak



BB-001
H 950, W 600, D 600mm

-  600mm wide wastebin cabinet with adjustable feet. Contains a drawer holding a removable plastic bin.
-  Meuble pour poubelle de 600mm de large à pieds réglables. Comprend un tiroir pour un bac amovible
-  600mm breiter Schrank für Abfallbehälter mit regelbaren Füßen. Enthält eine Schublade mit einem abnehmbaren Kunststoff-fach.
-  Armadio per pattumiera largo 600mm con piedini regolabili. Dispone di un cassetto con un bidone in plastica rimovibili.
-  Armario para basura de 600mm de ancho con patas ajustables. Incluye un cajón que sujeta un recipiente de plástico extraíble.
-  600mm brede kast voor afvalbak met instelbare poten. Bevat een lade met een uitneembare kunststof emmer.



BB-061
H 950, W 600, D 600mm

-  600mm wide wastebin cabinet with hinged top door. Contains a drawer holding a removable plastic bin and adjustable feet.
-  Meuble pour poubelle de 600 mm de large avec une porte supérieure montée sur charnières. Comprend un tiroir pour un bac amovible. Pieds réglables.
-  600mm breiter Schrank für Abfallbehälter mit Klapptür auf der Oberseite. Enthält eine Schublade mit einem abnehmbaren Kunststoff-fach. Regelbaren Füßen.
-  Armadio per pattumiera largo 600mm con anta superiore a battente. Dispone di un cassetto con un bidone in plastica rimovibili. Piedini regolabili.
-  Armario para basura de 600mm de ancho con puerta superior con bisagras. Incluye un cajón que sujeta un recipiente de plástico extraíble. Patas ajustables.
-  600mm brede kast voor afvalbak met bovendeur met scharnieren. Bevat een lade met een uitneembare kunststof emmer. Instelbare poten.



BUGT-061
H 950, W 600, D 600mm

-  600mm wide wastebin cabinet. Contains a drawer holding two removable metal bins for separating waste, with towel and glove dispenser drawer. Includes adjustable feet.
-  Meuble pour poubelle de 600mm de large. Comprend un tiroir pour deux bacs amovibles de tri des déchets, avec distributeurs de serviettes et de gants intégrés. Pieds réglables.
-  600mm breiter Schrank für Abfallbehälter. Enthält eine Schublade mit zwei abnehmbaren Metallbehältern zur Abfalltrennung, mit Handtuch- & Handschuhspendern. Einschließlich einstellbarer Füße.
-  Armadio per pattumiera largo 600mm. Dispone di un cassetto con due bidoni in metallici rimovibili per separare i rifiuti, con distributori di asciugamani e guanti. Include dei piedini regolabili.
-  Armario para basura de 600mm de ancho. Incluye un cajón que sujeta dos recipientes de metal extraíbles para separar los residuos, con dispensadores de toallas y guantes. Incluye patas ajustables.
-  600mm brede kast voor afvalbak. Bevat een lade met daarin twee uitneembare met metalen containersvoor het scheiden van afval, met handdoek/handschoen dispenser. Inclusief verstelbare poten.

900mm Wastebin Cabinets

900mm Rangements pour poubelle
900mm Schränke für Abfallbehälter
Armadi per pattumiera larghe 900mm
Armarios para basura de 900 mm de ancho
900mm Kasten met afvalbak



BB-091

H 950, W 900, D 600mm

-  900mm wide waste recycling cabinet. Contains a drawer holding two removable plastic bins for separating waste. Includes adjustable feet.
-  Meuble de collecte des déchets recyclables, largeur 900mm. Comprend un tiroir pour deux bacs amovibles de tri des déchets. Pieds réglables.
-  900mm breiter Abfallrecycling-Schrank. Enthält eine Schublade mit zwei abnehmbaren Kunststofffächern zur Abfalltrennung. Einschließlich einstellbarer Füße.
-  Armadio per il riciclaggio dei rifiuti largo 900mm. Dispone di un cassetto con due bidoni in plastica rimovibili per separare i rifiuti. Include dei piedini regolabili.
-  Armario de reciclaje de residuos de 900mm de anchura. Incluye un cajón que sujeta dos recipientes de plástico extraíbles para separar los residuos. Incluye patas ajustables.
-  900mm brede kast voor afvalrecycling. Bevat een lade met daarin twee uitneembare kunststof emmers voor het scheiden van afval. Inclusief verstelbare poten.



BB-093

H 950, W 900, D 600mm

-  900mm wide waste recycling cabinet. Contains a main drawer holding a removable plastic bin and two side drawers with metal containers. Includes adjustable feet.
-  Meuble de collecte des déchets recyclables, largeur 900 mm. Comprend un tiroir principal avec un bac amovible et deux tiroirs latéraux avec conteneurs métalliques. Pieds réglables.
-  900mm breiter Abfallrecycling-Schrank. Enthält eine Schublade mit eine abnehmbaren Kunststoff-Fach und zwei seitlichen Schubladen mit Metallbehältern. Einschließlich einstellbarer Füße.
-  Armadio per il riciclaggio dei rifiuti largo 900mm. Dispone di un cassetto principale con un bidone in plastica rimovibili e due cassetti laterali con contenitori metallici. Include dei piedini regolabili.
-  Armario de reciclaje de residuos de 900mm de anchura. Incluye un cajón principal que sujeta un recipiente de plástico extraíbles y dos cajones laterales con recipientes de metal. Incluye patas ajustables.
-  900mm brede kast voor afvalrecycling. Bevat een hoofdlade met daarin een uitneembare kunststof emmer en twee zijladen met metalen containers. Inclusief verstelbare poten.



BB-092

H 950, W 900, D 600mm

-  900mm wide waste recycling cabinet with hinged top door. Contains a main drawer holding a removable plastic bin and two side drawers with metal containers. Includes adjustable feet.
-  Meuble de collecte des déchets recyclables, largeur 900mm avec une porte supérieure montée sur charnières. Comprend un tiroir principal avec un bac amovible et deux tiroirs latéraux avec conteneurs métalliques. Pieds réglables.
-  900mm breiter Abfallrecycling-Schrank mit Klapptür auf der Oberseite. Enthält eine Schublade mit eine abnehmbaren Kunststoff-Fach und zwei seitlichen Schubladen mit Metallbehältern. Einschließlich einstellbarer Füße.
-  Armadio per il riciclaggio dei rifiuti largo 900mm con anta superiore a battente. Dispone di un cassetto principale con un bidone in plastica rimovibili e due cassetti laterali con contenitori metallici. Include dei piedini regolabili.
-  Armario de reciclaje de residuos de 900mm de anchura con puerta superior con bisagras. Incluye un cajón principal que sujeta un recipiente de plástico extraíbles y dos cajones laterales con recipientes de metal. Incluye patas ajustables.
-  900mm brede kast voor afvalrecycling met bovendeur met scharnieren. Bevat een hoofdlade met daarin een uitneembare kunststof emmer en twee zijladen met metalen containers. Inclusief verstelbare poten.



BB-090

H 950, W 900, D 600mm



-  900mm wastebin. Fitted with double doors to conceal internal bin on castors, and hinged top door. Includes adjustable feet.
-  Meuble pour poubelle de 900mm de large. Installé avec des portes doubles pour cacher la poubelle intérieure sur roulettes, porte supérieure montée sur charnières.
-  900mm breiter Abfallbehälter Mit Doppeltür vorn und Klapptür auf der Oberseite ausgestattet, um Abfallbehälter auf Rollen im Inneren zu verbergen. Einschließlich einstellbarer Füße..
-  Armadio per pattumiera largo 900mm. Attrezzato con anta doppia per nascondere una pattumiera interna su ruote orientabili, e anta superiore a battente. Include dei piedini regolabili.
-  Recipiente de basura de 900mm de ancho. Equipado con dos puertas para ocultar el recipiente interno sobre ruedas y puerta superior con bisagras. Incluye patas ajustables.
-  900mm brede kast voor afvalbak. Met dubbele deuren om afvalbak op wielen en bovendeur met scharnieren, aan het oog te onttrekken. Inclusief verstelbare poten.

1200mm Wastebin Cabinets

1200mm Rangements pour poubelle
1200mm Schränke für Abfallbehälter
Armadi per pattumiera larghe 1200mm
Armarios para basura de 1200 mm de ancho
1200mm Kasten met afvalbak



BB-127
H 950, W 1200, D 600mm

-  1200mm wide waste recycling cabinet. Contains a drawer holding two removable plastic bins for separating waste. Includes adjustable feet.
-  Meuble de collecte des déchets recyclables, largeur 1200mm. Comprend un tiroir pour deux bacs amovibles de tri des déchets. Pieds réglables.
-  1200 breiter Abfallrecycling-Schrank. Enthält eine Schublade mit zwei abnehmbaren Kunststofffächern zur Abfalltrennung. Einschließlich einstellbarer Füße.
-  Armadio per il riciclaggio dei rifiuti largo 1200mm. Dispone di un cassetto con due bidoni in plastica rimovibili per separare i rifiuti. Include dei piedini regolabili.
-  Armario de reciclaje de residuos de 1200mm de anchura. Incluye un cajón que sujeta dos recipientes de plástico extraíbles para separar los residuos. Incluye patas ajustables.
-  1200mm brede kast voor afvalrecycling. Bevat een lade met daarin twee uitneembare kunststof emmers voor het scheiden van afval. Inclusief verstelbare poten.



BB-120
H 950, W 1200, D 600mm

-  1200mm wide waste recycling cabinet. Contains a drawer holding three removable plastic bins for separating waste. Includes adjustable feet.
-  Meuble de collecte des déchets recyclables, largeur 1200mm. Comprend un tiroir pour trois bacs amovibles de tri des déchets. Pieds réglables.
-  1200mm breiter Abfallrecycling-Schrank. Enthält eine Schublade mit drei abnehmbaren Kunststofffächern zur Abfalltrennung. Einschließlich einstellbarer Füße.
-  Armadio per il riciclaggio dei rifiuti largo 1200mm. Dispone di un cassetto con tre bidoni in plastica rimovibili per separare i rifiuti. Include dei piedini regolabili.
-  Armario de reciclaje de residuos de 1200mm de anchura. Incluye un cajón que sujeta tres recipientes de plástico extraíbles para separar los residuos. Incluye patas ajustables.
-  1200mm brede kast voor afvalrecycling. Bevat een lade met daarin drie uitneembare kunststof emmers voor het scheiden van afval. Inclusief verstelbare poten.









BB-124
H 950, W 1200, D 600mm

-  1200mm wide waste recycling cabinet. Contains a main drawer holding two removable plastic bins and two side drawers with metal containers. Includes adjustable feet.
-  Meuble de collecte des déchets recyclables, largeur 1200 mm. Comprend un tiroir principal avec deux bacs en matière plastique et deux tiroirs latéraux avec conteneurs métalliques. Pieds réglables.
-  1200mm breiter Abfallrecycling-Schrank. Enthält eine Hauptschublade mit zwei abnehmbaren Kunststofffächern und zwei seitlichen Schubladen mit Metallbehältern. Einschließlich einstellbarer Füße.
-  Armadio per il riciclaggio dei rifiuti largo 1200mm. Dispone di un cassetto principale con due bidoni in plastica rimovibili e due cassette laterali con contenitori metallici. Include dei piedini regolabili.
-  Armario de reciclaje de residuos de 1200mm de anchura. Incluye un cajón principal que sujeta dos recipientes de plástico extraíbles y dos cajones laterales con recipientes de metal. Incluye patas ajustables.
-  1200mm brede kast voor afvalrecycling. Bevat een hoofdlade met daarin twee uitneembare kunststof emmers en twee zijladen met metalen containers. Inclusief verstelbare poten.



BB-125
H 950, W 1200, D 600mm

-  1200mm wide waste recycling cabinet. Contains a drawer holding three removable plastic bins for separating waste and a stainless steel access flap. Includes adjustable feet.
-  Meuble de collecte des déchets recyclables, largeur 1200mm. Contient un tiroir pour trois bacs amovibles de tri des déchets et un volet d'accès en acier inoxydable. Comprend des pieds réglables.
-  1200mm breiter Abfallrecycling-Schrank. Enthält eine Schublade mit drei abnehmbaren Kunststofffächern zur Abfalltrennung und eine Zugangsklappe aus Edelstahl. Einschließlich einstellbarer Füße.
-  Armadio per il riciclaggio dei rifiuti largo 1200mm. Dispone di un cassetto con tre bidoni in plastica rimovibili per separare i rifiuti e uno sportello di accesso in acciaio inossidabile. Include piedini regolabili.
-  Armario de reciclaje de residuos de 1200mm de anchura. Incluye un cajón que sujeta tres recipientes de plástico extraíbles para separar los residuos y una solapa de acceso de acero inoxidable. Incluye patas ajustables.
-  1200mm brede kast voor afvalrecycling. Bevat een lade met daarin drie uitneembare kunststof emmers voor het scheiden van afval en een roestvrijstalen toegangsklep. Inclusief verstelbare poten.

Sink cabinets

Blocs sous évier
Waschbeckenschränke
Armadi per lavelli
Armarios sumideros
Kasten met gootsteen







BS-001
H 950, W 600, D 600mm

-  600mm sink cabinet. Fitted with stainless steel bowl, taps and waste outlet, with lockable door.
-  Bloc sous évier, largeur 600mm. Installé avec une cuve en acier inoxydable, robinets et évacuation des déchets, porte verrouillable.
-  600mm breiter Waschbeckenschrank. Mit Edelstahlbecken, Wasserhähne und Abfluss ausgestattet sowie verschließbarer Tür.
-  Armadio per lavelli largo 600mm. Attrezzato con vasca di acciaio inossidabile, rubinetti e scarico per i rifiuti, con anta chiudibile a chiave.
-  Armarios sumideros de 600mm de anchura. Equipados con una cuba de acero inoxidable, grifos y salida de desperdicios, con puerta cerrada con llave.
-  600mm brede kast met gootsteen. Met roestvrijstalen bak, Kranen en afvoerbuis, met afsluitbare deur.



BS-090
H 950, W 900, D 600mm

-  900mm wide sink cabinet. Fitted with deep stainless steel bowl, taps and waste outlet, with lockable double doors.
-  Bloc sous évier, largeur 900mm. Installé avec une cuve profonde en acier inoxydable, robinets et évacuation des déchets, portes doubles verrouillables.
-  900mm breiter Waschbeckenschrank. Mit tiefem Edelstahlbecken, Wasserhähne und Abfluss ausgestattet sowie verschließbarer Doppeltür.
-  Armadio per lavelli largo 900mm. Attrezzato con vasca di acciaio inossidabile, rubinetti e scarico per i rifiuti, con ante doppie chiudibili a chiave.
-  Armarios sumideros de 900mm de anchura. Equipados con una cuba de acero inoxidable, grifos y salida de desperdicios, con dos puertas cerradas con llave.
-  900mm brede kast met gootsteen. Met roestvrijstalen bak, Kranen en afvoerbuis, met afsluitbare dubbele deuren.



BS-120
H 950, W 1200, D 600mm

-  1200mm wide sink cabinet. Fitted with deep stainless steel bowl, taps and waste outlet, with lockable double doors.
-  Bloc sous évier, largeur 1200mm. Installé avec une cuve profonde en acier inoxydable, robinets et évacuation des déchets, portes doubles verrouillables.
-  1200mm breiter Waschbeckenschrank. Mit tiefem Edelstahlbecken, Wasserhähne und Abfluss ausgestattet sowie verschließbarer Doppeltür.
-  Armadio per lavelli largo 1200mm. Attrezzato con vasca di acciaio inossidabile, rubinetti e scarico per i rifiuti, con ante doppie chiudibili a chiave.
-  Armarios sumideros de 1200mm de anchura. Equipados con una cuba de acero inoxidable, grifos y salida de desperdicios, con dos puertas cerradas con llave.
-  1200mm brede kast met gootsteen. Met roestvrijstalen bak, Kranen en afvoerbuis, met afsluitbare dubbele deuren.



BS-121
H 950, W 1200, D 600mm

-  1200mm wide sink cabinet. Fitted with two deep stainless steel bowl, taps and waste outlet, with lockable double doors.
-  Bloc sous évier largeur 1200mm. Installé avec deux cuvettes profondes en acier inoxydable, robinets et évacuation des déchets, portes doubles verrouillables.
-  1200mm breiter Waschbeckenschrank. Mit zwei tiefe Edelstahlbecken, Wasserhähne und Abfluss ausgestattet sowie verschließbarer Doppeltür.
-  Armadio per lavelli largo 1200mm. Attrezzato con due vasche di acciaio inossidabile, rubinetti e scarico per i rifiuti, con ante doppie chiudibili a chiave.
-  Armarios sumideros de 1200mm de anchura. Equipados con dos cuba de acero inoxidable, grifos y salida de desperdicios, con dos puertas cerradas con llave.
-  1200mm brede kast met gootsteen. Met twee roestvrijstalen bakken, Kranen en afvoerbuis, met afsluitbare dubbele deuren.



Stainless steel worktop option
Surface en acier inoxydable
Arbeitsauflage aus Edelstahl

Top di acciaio inossidabile
Parte superior de acero inoxidable
Roestvrij staal blad



Stainless steel worktop option
Surface en acier inoxydable
Arbeitsauflage aus Edelstahl







Top di acciaio inossidabile
Parte superior de acero inoxidable
Roestvrij staal blad

Computer / diagnostic cabinets

Armoires informatiques / de diagnostic
Computer- / Diagnostikschränke
Armadi per computer / diagnostici
Armarios de ordenador / diagnóstico
Computer- / diagnosekasten



BU-021/021L
H 950, W 600, D 600mm

-  600mm wide base cabinet. Contains lower sliding shelf ideal for storing a computer printer.
-  Placard de rangement de 600mm de large. Comporte une étagère inférieure coulissante, idéale pour une imprimante.
-  600mm breiter Unterschrank. Mit Einlegeboden auf Schienen unten, ideal für einen Computer oder Drucker.
-  Armadio basso largo 600mm. Contiene una ripiano scorrevole inferiore ideale per metterci la stampante di un computer.
-  Armario de base de 600mm de ancho. Contiene una repisa inferior deslizante ideal para colocar una impresora de ordenador.
-  Onderkast 600mm breed. Met uitschuifplateau, ideaal voor printer.









BU-021



BU-021L



BU-091
H 950, W 900, D 600mm

-  900mm wide base cabinet. Contains lower sliding shelf ideal for storing a computer printer.
-  Placard de rangement de 900mm de large. Comporte une étagère inférieure coulissante, idéale pour une imprimante.
-  900mm breiter Unterschrank. Mit Einlegeboden auf Schienen unten, ideal für einen Computer oder Drucker.
-  Armadio basso largo 900mm. Contiene una ripiano scorrevole inferiore ideale per metterci la stampante di un computer.
-  Armario de base de 900mm de ancho. Contiene una repisa inferior deslizante ideal para colocar una impresora de ordenador.
-  Onderkast 900mm breed. Met uitschuifplateau, ideaal voor printer.



BU-121
H 950, W 1200, D 600mm

-  1200mm wide base cabinet. Contains lower sliding shelf ideal for storing a computer printer.
-  Placard de rangement de 1200mm de large. Comporte une étagère inférieure coulissante, idéale pour une imprimante.
-  1200mm breiter Unterschrank. Mit Einlegeboden auf Schienen unten, ideal für einen Computer oder Drucker.
-  Armadio basso largo 1200mm. Contiene una ripiano scorrevole inferiore ideale per metterci la stampante di un computer.
-  Armario de base de 1200mm de ancho. Contiene una repisa inferior deslizante ideal para colocar una impresora de ordenador.
-  Onderkast 1200mm breed. Met uitschuifplateau, ideaal voor printer.



CP-060 & CP-061
H 2000, W 600, D 600mm

-  600mm wide tall computer cabinet with VDU window, sliding keyboard shelf and server cupboard. Lockable door and adjustable feet.
-  Armoire informatique haute de 600mm de large avec fenêtre de visualisation, étagère coulissante pour clavier et placard destiné à l'unité centrale. Porte verrouillable et pieds ajustables.
-  Schmäler Computerschrank mit 600mm Breite und Monitorfenster, Tastatur-Schublade auf Schienen und Schrank für den PC. Verschiebbare Tür und regelbare Füße.
-  Armadio alto per computer largo 600mm con finestra per unità video, ripiano con tastierino numerico scorrevole e armadio per il server. Con anta chiudibile a chiave e piedini regolabili.
-  Armario alto de ordenador de 600mm de ancho con ventana VDU, repisa de corredera para teclado y espacio para servidor. Puerta cerrada con llave y patas ajustables.
-  Computerkast 600mm breed met VDU scherm, uitschuifplateau voor toetsenbord en serverkast. Afsluitbare deur en verstelbare poten.



CP-060
Steel frame with perspex centre



CP-061
Full perspex

Keyboard tray and monitor mounting system

Système d'installation d'un tiroir pour clavier et d'un moniteur
Tastatur-Schublade und Monitor-Montagesystem
Ripiano per tastiera e sistema di montaggio per monitor
Sistema de montaje de la bandeja para teclado y el monitor
Toetsenbordplateau en montagesysteem voor monitor

System for mounting a monitor and a keyboard tray or a laptop tray to a back panel.

Système d'installation d'un moniteur et d'un tiroir pour clavier ou d'un tiroir pour ordinateur portable sur un panneau arrière.

System zur Montage eines Monitors und einer Tastatur- oder Laptop-Schublade an einer Rückwand.

Sistema per montare un monitor e un ripiano per tastiera o laptop sui pannelli posteriori.

Sistema para montar un monitor y una bandeja para teclado o una bandeja para ordenador portátil en un panel trasero.

Systeem voor de montage van een monitor en een toetsenbord- of laptopplateau aan een achterwand.

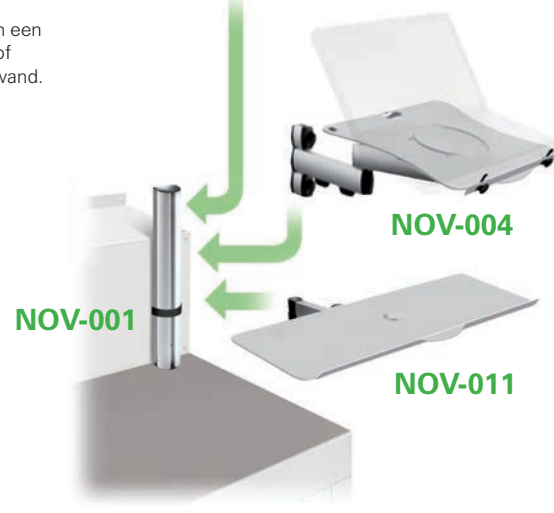
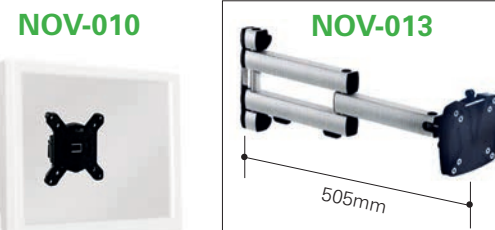

For further options of diagnostic wall cabinets, please turn to **pages 101-102**.
Pour d'autres options d'armoires murales de diagnostic, consultez les **pages 101-102**.
Siehe **Seite 101-102** für weitere Wahlmöglichkeiten für Diagnostik-Wandschränke.
Per ulteriori opzioni degli armadi a muro diagnostici, consultare le **pagine 101-102**.
Para mayores opciones de armarios murales de diagnóstico, remítase a las **páginas 101-102**.
Raadpleeg voor andere opties of diagnose-wandkasten de **pagina's 101-102**.

Workdesk cabinets

Bureaux de travail à rangement
Arbeits-tisch-Schränke
Armadi banchi da lavoro
Armarios de escritorio
Werkbladkasten



BU-124

H 950, W 1200, D 600mm

1200mm wide base cabinet with tambour door to provide legroom for seated user and storage space for a stool. Contains two extra-deep sliding drawers and provision for power sockets. Stool not included.

Meuble de rangement large de 1200 mm, équipé de volets roulants pour offrir un dégagement pour les jambes de l'utilisateur en position assise et un espace pour ranger un tabouret. Contient deux tiroirs coulissants extra profonds et un emplacement pour prises électriques. Tabouret non inclus.

1200mm breiter Unterschrank mit Rolltür für Beinfreiheit bei sitzender Tätigkeit und Stauraum für einen Stuhl. Mit zwei extratiefen Schubladen und Steckdosenvorrichtung. Stuhl nicht im Lieferumfang enthalten.

Armadio con base da 1200mm con sportello a saracinesca che consente una comoda seduta dell'utente e spazio aggiuntivo per uno sgabello. Contiene due cassetti scorrevoli extra profondi e la predisposizione per le prese elettriche. Sgabello non in dotazione.

Armario de base ancho de 1200mm con puerta de tambor que ofrece espacio para las piernas al usuario sentado y espacio de almacenamiento para un taburete. Contiene dos cajones deslizantes extraprofundos y hueco para enchufes de alimentación. Taburete no incluido.

1200mm brede basiskast met roldeur biedt beuruimte voor zittende gebruiker en opbergruimte voor een kruk. Heeft twee extra diepe schuifladen en voorziening voor stopcontacten. Kruk niet inbegrepen.

Workdesk cabinets

Bureaux de travail à rangement
Arbeits-tisch-Schränke
Armadi banchi da lavoro
Armarios de escritorio
Werkbladkasten



BU-095



H 950, W 900, D 600mm

-  900mm wide base cabinet with projecting work surface to provide legroom for seated user. Contains double sliding doors and vented rear panel and provision for power sockets to allow storage of computer. Plug socket and stool not included. ***This unit should be fixed securely on both sides to other cabinets.***
-  Meuble de rangement de base, largeur 900 mm, équipé d'une surface de travail en saillie avec dégagement pour les jambes de l'utilisateur en position assise. Composé d'une double porte coulissante, d'un panneau d'aération arrière et d'un emplacement pour prises électriques afin d'installer un processeur d'ordinateur. Prise de courant et tabouret non inclus. ***Cette unité doit être solidement fixée des deux côtés aux autres meubles de rangement.***
-  900mm breiter Unterschrank mit hervorstehender Arbeitsoberfläche für Beinfreiheit bei sitzender Tätigkeit. Mit doppelten Schiebetüren, einer belüfteten Rückwand und Steckdosenvorrichtung, sodass ein Computer untergebracht werden kann. Steckdose und Stuhl nicht im Lieferumfang enthalten. ***Diese Einheit sollte an beiden Seiten fest mit anderen Schränken verbunden werden.***
-  Armadio con base da 900 mm e una superficie da lavoro sporgente che consente una comoda seduta dell'utente. Contiene due sportelli scorrevoli e un pannello posteriore aperto, oltre alla predisposizione per prese elettriche per alloggiare un processore PC. Presa elettrica e sgabello non in dotazione. ***Entrambi i lati di questa unità devono essere fissati in modo sicuro agli altri armadi.***
-  Armario de base ancho de 900 mm con superficie de trabajo saliente que proporciona espacio para las piernas al usuario sentado. Contiene puertas correderas dobles y un panel trasero ventilado, así como hueco para enchufes de alimentación para poder guardar el procesador del ordenador. Toma de corriente y taburete no incluidos. ***Esta unidad debe fijarse de manera segura a otros armarios por ambos lados.***
-  900 mm brede basiskast met overhangend werkblad biedt beenruimte voor zittende gebruiker. Heeft dubbele schuifdeuren en een geventileerd achterpaneel met voorziening voor stopcontacten om een computerkast erin te kunnen plaatsen. Stopcontact en kruk niet inbegrepen. ***Deze unit moet aan beide zijanten veilig worden vastgezet aan andere kasten.***



BU-065



H 950, W 600, D 600mm

-  600mm wide base cabinet with projecting work surface to provide legroom for seated user. Contains hinged door and vented rear panel and provision for power sockets to allow storage of computer. Plug socket and stool not included. ***This unit should be fixed securely on both sides to other cabinets.***
-  Meuble de rangement de base, largeur 600 mm, équipé d'une surface de travail en saillie avec dégagement pour les jambes de l'utilisateur en position assise. Composé d'une porte montée sur charnières, d'un panneau d'aération arrière et d'un emplacement pour prises électriques afin d'installer un processeur d'ordinateur. Prise de courant et tabouret non inclus. ***Cette unité doit être solidement fixée des deux côtés aux autres meubles de rangement.***
-  600mm breiter Unterschrank mit hervorstehender Arbeitsoberfläche für Beinfreiheit bei sitzender Tätigkeit. Mit Flügeltür, einer belüfteten Rückwand und Steckdosenvorrichtung, sodass ein Computer untergebracht werden kann. Steckdose und Stuhl nicht im Lieferumfang enthalten. ***Diese Einheit sollte an beiden Seiten fest mit anderen Schränken verbunden werden.***
-  Armadio con base da 600 mm e una superficie da lavoro sporgente che consente una comoda seduta dell'utente. Contiene anta a battente e un pannello posteriore aperto, oltre alla predisposizione per prese elettriche per alloggiare un processore PC. Presa elettrica e sgabello non in dotazione. ***Entrambi i lati di questa unità devono essere fissati in modo sicuro agli altri armadi.***
-  Armario de base ancho de 600 mm con superficie de trabajo saliente que proporciona espacio para las piernas al usuario sentado. Contiene una puerta bisagras y un panel trasero ventilado, así como hueco para enchufes de alimentación para poder guardar el procesador del ordenador. Toma de corriente y taburete no incluidos. ***Esta unidad debe fijarse de manera segura a otros armarios por ambos lados.***
-  600 mm brede basiskast met overhangend werkblad biedt beenruimte voor zittende gebruiker. Heeft een scharnierende deur en een geventileerd achterpaneel met voorziening voor stopcontacten om een computerkast erin te kunnen plaatsen. Stopcontact en kruk niet inbegrepen. ***Deze unit moet aan beide zijanten veilig worden vastgezet aan andere kasten.***

Cabinets for electrical facilities

Armoires pour installations électriques
Schränke für elektrische Anlagen
Armadi per impianti elettrici
Armarios para instalaciones electricas
Kasten voor elektrische voorzieningen









BU-023 H 950mm W 600mm D 600mm  x2
BU-032 H 950mm W 300mm D 600mm  x2

-  Low-level air & electrical management cabinets which can be custom fitted with up to two air or electrical reels. Contains adjustable feet.
-  Armoires basses pour enrouleurs de tuyau d'air comprimé ou de câble électrique, personnalisables avec deux enrouleurs de tuyau d'air comprimé ou de câble électrique. Prise pieds réglables.
-  Niedrige Schränke für Luft- und Elektrik-Aufroller-Management, Ausstattung mit bis zu zwei Luft- oder Elektrik-Aufrollern möglich. Mit einstellbaren Füßen.
-  Armadi bassi per la gestione degli impianti per aria ed elettricità, personalizzabili con un massimo di due bobine per aria o elettricità. Dispone piedini regolabili.
-  Armarios de gestión de carretes de aire de nivel bajo y eléctricos que pueden personalizarse con hasta dos carretes de aire o eléctricos. Incluye patas ajustables.
-  Lage kasten voor beheer van rollen voor lucht en elektriciteit die op maat kunnen worden uitgerust met maximaal twee rollen voor luchtleidingen of elektrische kabels. Met instelbare poten.





VRD-450 H 2000mm W 450mm D 600mm  x3

-  2m high cabinet for air supply and battery charging. Includes glove and towel dispenser.
-  Armoire haute de 2 m pour l'alimentation en air et le chargement de la batterie. Comprend un distributeur de gants/papier d'essuyage.
-  2m hoher Schrank für Luftversorgung und Batterieladung. Inklusive Handschuh- und Handtuchspender.
-  Armadio alto 2m per alimentazione aria e ricarica batteria. Include dispenser di guanti e salviette.
-  Armario de 2m de altura para suministro de aire y carga de batería. Incluye dispensador de guantes y toallitas.
-  2m hoge kast voor luchttoevoer en batterij opladen. Inclusief handschoen- en handdoekautomaat.





CUC-006 H 2000mm W 600mm D 600mm  

-  2m high heavy-duty shelving with ventilation holes, for electrical charging. Includes 5 adjustable shelves. Power sockets not included. **Please call for further details.**
-  Armoire de rangement haute avec trous de ventilation pour la charge électrique. Comprend 5 étagères ajustables. Prises électriques non incluses. **Veillez appeler pour plus de détails.**
-  Schmalere Schrank mit Belüftungsöffnungen zum elektrischen Laden. Enthält 5 verstellbare Einlegeböden. Steckdosen nicht im Lieferumfang enthalten. **Bitte rufen Sie uns für weitere Details an.**
-  Armadio alto con fori di ventilazione per ricarica elettrica. Include 5 ripiani regolabili. Prese di corrente non incluse. **Si prega di chiamare per ulteriori dettagli.**
-  Armario de base con orificios de ventilación para carga eléctrica. Incluye 5 repisas ajustables. Enchufes de alimentación no incluidas. **Llame para obtener más detalles.**
-  Hoge onderkast met ventilatiegaten voor elektrisch opladen. Bevat 5 verstelbare legplanken. Stopcontacten niet inbegrepen. **Bel voor meer informatie.**



RSC-092 H 2000mm W 900mm D 600mm  

-  2m high heavy-duty shelving with ventilation holes, for electrical charging. Includes 5 adjustable shelves. Power sockets not included. **Please call for further details.**
-  Unités de 2 m de haut pour la charge électrique avec trous de ventilation. Comprend 5 étagères ajustables. Prises électriques non incluses. **Veillez appeler pour plus de détails.**
-  2m hohes Hochleistungsregal mit Belüftungsöffnungen zum elektrischen Laden. Enthält 5 verstellbare Einlegeböden. Steckdosen nicht im Lieferumfang enthalten. **Bitte rufen Sie uns für weitere Details an.**
-  Unità alte 2m per ricarica elettrica con fori di ventilazione. Include 5 ripiani regolabili. Prese di corrente non incluse. **Si prega di chiamare per ulteriori dettagli.**
-  Las unidades de 2m con orificios de ventilación para carga eléctrica. Incluye 5 repisas ajustables. Enchufes de alimentación no incluidas. **Llame para obtener más detalles.**
-  2m hoge units met ventilatiegaten voor elektrisch opladen. Bevat 5 verstelbare legplanken. Stopcontacten niet inbegrepen. **Bel voor meer informatie.**



Maximum number of reels
Nombre d'enroulements maximal
Maximale Anzahl an Aufrollern
Numero massimo di bobine
Cantidad máxima de carretes
Maximum aantal rollen



Reels not included
Enrouleurs pas inclus
Aufroller nicht eingeschlossen
Le bobine non sono incluse
Los carretes no son incluidos
Rollen niet inbegrepen

Wall Cabinets and Under-Cabinet Lighting

Armoires murales et éclairage sous l'armoire
Wandschränke und Unterschrankbeleuchtungen
Armadi a muro e illuminazione inferiore
Armarios de muro y alumbrado bajo los armarios
Wandkasten en verlichting onder kasten



Wall cabinets and under cabinet lighting

Designed to accommodate a range of features at high-level for improved efficiency and to maximise storage space. Lockable doors open vertically supported with gas struts for smooth operation.

Product features include:

- A** 600, 900 & 1200mm width cabinets
- B** 2-point locking vertical door on gas struts
- C** Optional adjustable shelf
- D** Optional towel and latex glove dispensers
- E** Optional under-cabinet lighting
- F** Optional VDU window and keyboard tray

Armoires murales et éclairage sous l'armoire

Conçus pour s'adapter à diverses configurations en hauteur pour une efficacité maximale et pour optimiser l'espace de rangement. Les portes verrouillables s'ouvrent à la verticale sur des amortisseurs à gaz pour une utilisation fluide.

Les caractéristiques du produit comprennent:

- A** Armoires de 600, 900 et 1200mm de large
- B** Porte verticale avec serrure en 2 points. Porte sur amortisseurs à gaz
- C** En option, étagère ajustable
- D** En option, distributeurs de serviettes et de gants en latex
- E** En option, éclairage sous l'armoire
- F** En option fenêtre de visualisation et plateau destiné au clavier

Wandschränke und Unterschrankbeleuchtungen

Entwickelt, um sich vielen Anordnungen auf hohem Niveau mit dem Ziel anzupassen, die Effizienz zu verbessern und maximalen Stauraum zu bieten. Verschiebbare Türen lassen sich vertikal öffnen und werden mit Gasdruckfedern für den leichtgängigen Betrieb abgestützt.

Die Produkteigenschaften umfassen:

- A** 600, 900 & 1200mm breite Schränke
- B** Vertikale Tür mit 2-Punkt-Verriegelung. Tür auf Gasdruckfedern
- C** Verstellbarer Einlegeboden auf Wunsch
- D** Handtuch- und Latexhandschuhspender auf Wunsch
- E** Unterschrankbeleuchtung auf Wunsch
- F** Monitorfenster und Tastatur-Schublade auf Wunsch

Armadi a muro e illuminazione inferiore

Progettati per adattarsi a una gamma di caratteristiche di alto livello per ottenere un'efficienza migliorata e uno spazio di stoccaggio massimizzato. Ante chiudibili a chiave che si aprono verticalmente e dotate di puntoni a gas per una facile operazione.

Le caratteristiche del prodotto comprendono:

- A** Armadi larghi 600, 900 e 1200mm
- B** Anta verticale bloccabile in 2 punti. Ante su puntoni a gas
- C** Ripiano regolabile opzionale
- D** Distributori di asciugamani e guanti di lattice opzionali
- E** Illuminazione per la parte inferiore dell'armadio opzionale
- F** Finestra per unità video e ripiano per tastiera

Armarios de muro y alumbrado bajo los armarios

Diseñado para contener una hilera de dispositivos en altura para mejorar la eficiencia y aumentar el espacio de almacenamiento. Puertas cerradas con llave soportadas verticalmente por cilindros de gas para un funcionamiento suave.

El producto tiene las características siguientes:

- A** Armarios de 600, 900 y 1200mm de ancho
- B** Puerta vertical con cierre en 2 puntos. Puerta con cilindros de gas
- C** Repisa ajustable opcional
- D** Dispensador de toallas y guantes de latex
- E** Alumbrado bajo el armario opcional
- F** Ventana VDU y bandeja de teclado opcionales

Wandkasten en verlichting onder kasten

Ontworpen om voorwerpen hoog op te bergen om bergruimte te optimaliseren. Afsluitbare deuren openen vertikaal, ondersteund met gasgevulde veerpoten voor gemakkelijke bediening.

Technische kenmerken:

- A** Kasten 600, 900 & 1200mm breed
- B** Verticale deur met tweepuntssluiting. Deur met gasgevulde veerpoten
- C** Optionele verstellbare legplank
- D** Optionele handdoek- en handschoen dispenser
- E** Optionele verlichting onder kast
- F** Optioneel VDU-scherm en plateau voor toetsenbord

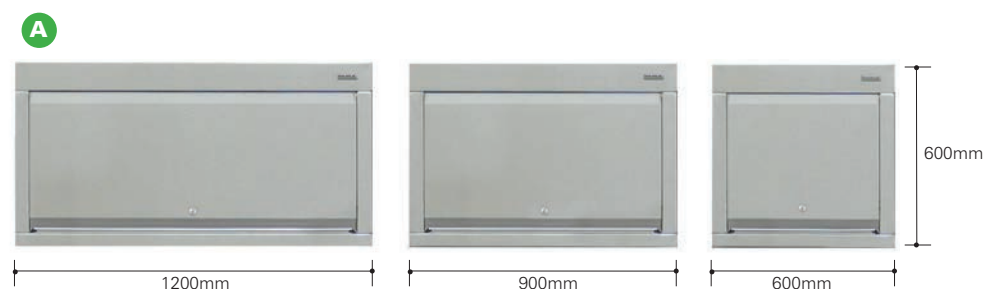
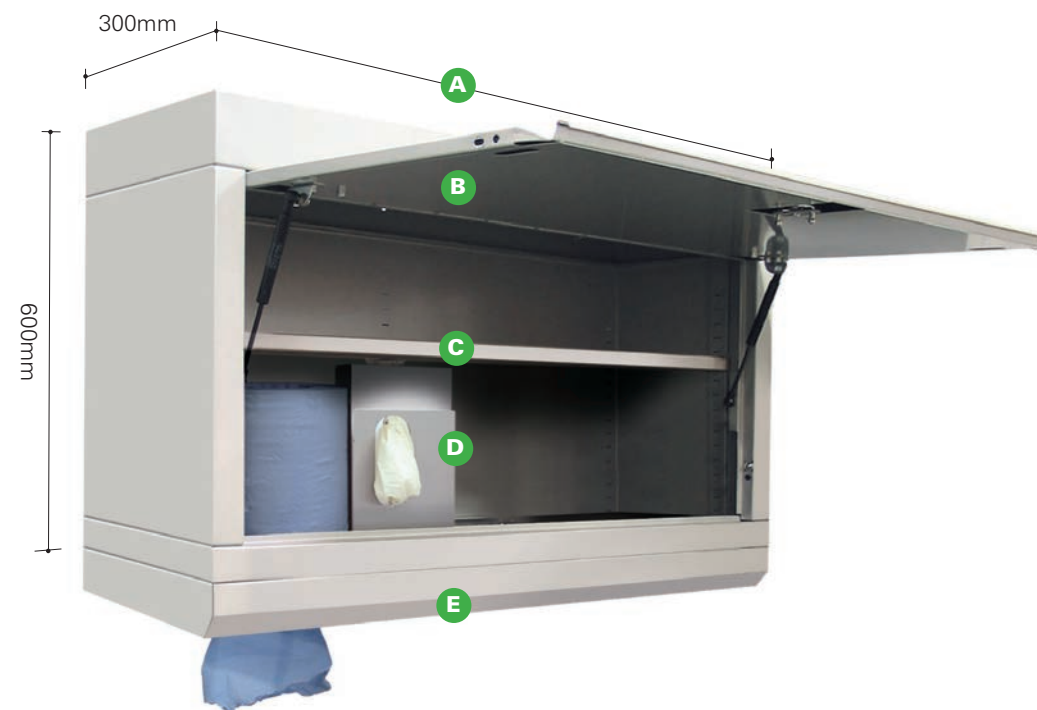

Cabinets with shelf

Armoires avec étagère
Schränke mit Einlegeboden
Armadi con ripiano
Armarios con repisas
Kasten met legplank





 600, 900 or 1200mm wide cabinet with lockable vertical door on gas struts and adjustable inner shelf.

 Armoire de 600, 900 ou 1200mm de large avec porte verticale verrouillable sur amortisseurs à gaz et étagère intérieure ajustable.

 600, 900 oder 1200mm breite Schränke mit verschließbarer vertikaler Tür auf Gasdruckfedern und verstellbarem Einlegeboden.

 Armadio largo 600, 900 o 1200mm con anta verticale chiudibile a chiave con puntoni a gas e ripiano interno regolabile.

 Armario de 600, 900 o 1200mm de ancho con puerta vertical cerrada con llave soportada por cilindros de gas y repisa interior ajustable.

 Kast 600, 900 en 1200mm met afsluitbare verticale deur met gasgevulde veerpoten en verstelbare legplank.

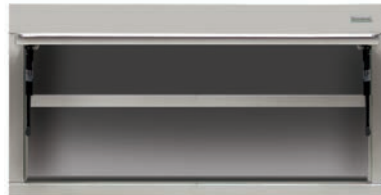

WU-120
H 600, W 1200, D 300mm



WU-090
H 600, W 900, D 300mm





WU-060
H 600, W 600, D 300mm

Cabinets with shelf and power points

Armoires avec étagère
Schränke mit Einlegeboden
Armadi con ripiano
Armarios con repisas
Kasten met legplank





 600, 900 or 1200mm wide cabinet with lockable vertical door on gas struts, adjustable inner shelf and power points.

 Armoire de 600, 900 ou 1200mm de large avec porte verticale verrouillable sur amortisseurs à gaz, étagère intérieure ajustable et points d'alimentation internes.

 600, 900 oder 1200mm breite Schränke mit verschließbarer vertikaler Tür auf Gasdruckfedern, verstellbarem Einlegeboden und Stromanschlüsse.

 Armadio largo 600, 900 o 1200mm con anta verticale chiudibile a chiave con puntoni a gas, e ripiano interno regolabile e prese.

 Armario de 600, 900 o 1200mm de ancho con puerta vertical cerrada con llave soportada por cilindros de gas y repisa interior ajustable y puntos de alimentación.

 Kast 600, 900 en 1200mm met afsluitbare verticale deur met gasgevulde veerpoten en verstelbare legplank und contactdozen.



WUE-120
H 600, W 1200, D 300mm



WUE-090
H 600, W 900, D 300mm



WUE-060
H 600, W 600, D 300mm

Cabinets with towel & glove dispensers

Armoires avec distributeurs de serviettes et de gants
 Schrank mit Handtuch- & Handschuhspendern
 Armadi con distributori di asciugamani e guanti
 Armarios con dispensadores de toallas y guantes
 Kasten met handdoek/handschoen dispensers

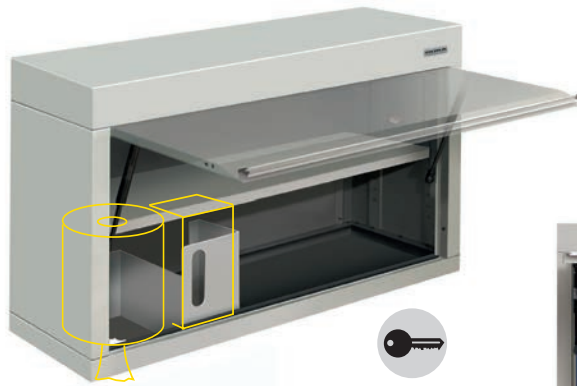

WUIT-120
 H 600, W 1200, D 300mm



WUIT-090
 H 600, W 900, D 300mm





WUIT-060
 H 600, W 600, D 300mm

 600, 900 or 1200mm wide cabinet with vertical door, towel and glove dispenser and adjustable inner shelf.

 Armoire de 600, 900 ou 1200mm de large avec porte verticale, distributeur de serviettes et de gants et étagère intérieure ajustable.

 600, 900 oder 1200mm breite Schränke mit vertikaler Tür, Handtuch- und Handschuhspender sowie verstellbarem Einlegeboden.

 Armadio largo 600, 900 o 1200mm con anta verticale, distributore di asciugamani e guanti e ripiano interno regolabile.

 Armario de 600, 900 o 1200mm de ancho con puerta vertical, dispensador de toallas-guantes y repisa interior ajustable.

 Kast 600, 900 en 1200mm met afsluitbare verticale deur, handdoek/handschoen dispenser en verstelbare legplank.

Cabinets with mounted monitor

Armoires avec moniteur intégré
 Schrank mit eingebautem Monitor
 Armadi con monitor da montare
 Armarios con monitor montado
 Kasten met ingebouwde monitor



WUVDU-120
 H 600, W 1200, D 300mm



WUVDU-090
 H 600, W 900, D 300mm



WUVDU-060
 H 600, W 600, D 300mm

 600, 900 or 1200mm wide cabinet with vertical door containing an aperture for mounting a custom monitor. Internal power points.

Specify monitor when ordering custom doors.

 Armoire de 600, 900 ou 1200mm de large avec porte verticale comportant une ouverture pour intégrer un moniteur personnalisé. Points d'alimentation internes.

Spécifier le moniteur lors de la commande des portes personnalisées.

 600, 900 oder 1200mm breiter Schrank mit vertikaler Tür mit einer Öffnung für den Einbau eines üblichen Monitors. Stromanschlüsse im Inneren.

Den Monitor angeben, wenn diese Türen bestellt werden.

 Armadio largo 600, 900 o 1200mm con anta verticale chiudibile contenente una apertura per montare un monitor su misura. Prese interne.

Specificare il monitor quando si ordinano ante su misura.

 Armario de 600, 900 o 1200mm de ancho con puerta vertical cerrada que dispone de una abertura para montar un monitor personalizado. Puntos de alimentación al interior.

Especificar el monitor cuando se piden puertas personalizadas.

 Kast 600, 900 of 1200mm met verticale deur met opening voor ingebouwde monitor. Interne contactdozen.

Vermeld monitor bij bestellen van speciale deuren.

Maximum screen sizes:
 Tailles d'écran maximales:
 Maximale Bildschirmgröße:
 Dimensioni massime dello schermo:
 Tamaños máximos de pantalla:
 Maximale schermafmetingen:

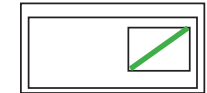

1200mm = 23"
 900mm = 23"
 600mm = 17"

Cabinets with towel/glove dispenser and mounted monitor

Armoires avec distributeur de serviettes/de gants et moniteur intégré
 Schränke mit Handtuch-/ Handschuhspender und eingebautem Monitor
 Armadi con distributore di asciugamani/guanti e monitor da montare
 Armarios con dispensador de toallas/guantes y con monitor montado
 Kasten met handdoek/handschoen dispenser en inbouw van monitor

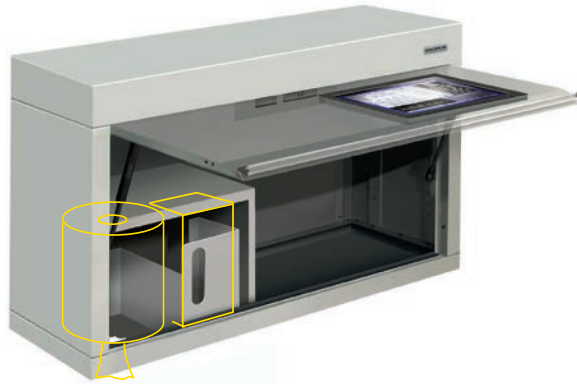

Maximum screen sizes:
 Tailles d'écran maximales:
 Maximale Bildschirmgröße:
 Dimensioni massime dello schermo:
 Tamaños máximos de pantalla:
 Maximale schermafmetingen:

1200mm = 23"
900mm = 23"
600mm = 17"

900 or 1200mm wide cabinet with vertical door containing an aperture for mounting a custom monitor. Internal power points. Includes towel and glove dispenser.

Specify monitor when ordering custom doors.

Armoire de 900 ou 1200mm de large avec porte verticale comportant une ouverture pour intégrer un moniteur personnalisé. Points d'alimentation internes. Comprend distributeur de serviettes et de gants.

Spécifier le moniteur lors de la commande des portes personnalisées.

900 oder 1200mm breiter Schrank mit vertikaler Tür mit einer Öffnung für den Einbau eines üblichen Monitors. Stromanschlüsse im Inneren. Enthält Handtuch- und Handschuhspender.

Den Monitor angeben, wenn diese Türen bestellt werden.

Armadio largo 900 o 1200mm con anta verticale chiudibile contenente una apertura per montare un monitor su misura. Prese interne. Include distributore di asciugamani e guant.

Specificare il monitor quando si ordinano ante su misura.

Armario de 900 o 1200mm de ancho con puerta vertical cerrada que dispone de una abertura para montar un monitor personalizado. Puntos de alimentación al interior. Incluye dispensador de toallas-guantes.

Especificar el monitor cuando se piden puertas personalizadas.

Kast 900 of 1200mm met verticale deur met opening voor ingebouwde monitor. Interne contactdozen. Bevat handdoek/handschoen dispenser.

Vermeld monitor bij bestellen van speciale deuren.



WUVDT-120
H 600, W 1200, D 300mm



WUVDT-090
H 600, W 900, D 300mm

Wall filing cabinet

Meuble d'archivage de mur
 Wandaktenschrank
 Armadietto di archivio della parete
 Cabina de clasificación de la pared
 De archiefkast van de muur

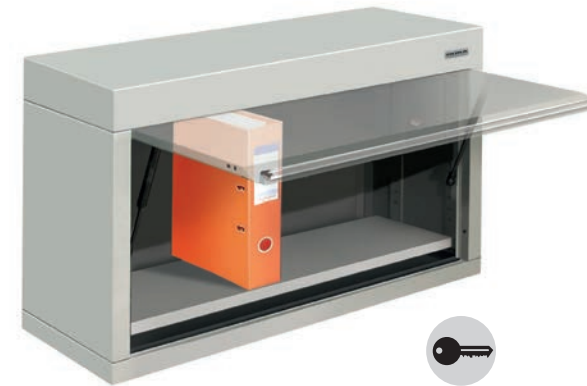

Extended depth wall cabinet to accommodate lever-arch files. For installations with vertical supports only.

Module étendu de mur de profondeur pour faciliter des fichiers de levier-voûte. Pour des installations avec les supports verticaux seulement.

Tieferer Wandschrank um Ordner unterzubringen. Für Installationen mit nur vertikalem Support.

Lungo armadietto a parete per accomodare gli archivi dell'leva-arco. Per le installazioni con i supporti verticali soltanto.

Cabina extendida de la pared de la profundidad para acomodar ficheros del palanca-arco. Para las instalaciones con las ayudas verticales solamente.

Het uitgebreide kabinet van de dieptemuur om hefboom-boog dossiers aan te passen. Voor installaties met verticale slechts steunen.



WUFC-120
H 600, W 1200, D 330mm



WUFC-090
H 600, W 900, D 330mm

Wall cabinets with tambour doors

Armoires murales avec fermeture à rideau
Wandschränke mit Rolltüren
Armadi a parete con ante a tamburo
Armarios murales con puertas de tambor
Wandkasten met jaloeziedeuren



-  1045mm high wall cabinet with lockable tambour door. Contains internal square peg panel for tool storage.
-  Armoire murale, hauteur 1045 mm pour moniteur et clavier avec porte à rideau verrouillable. Intègre un panneau perforé pour le rangement des outils.
-  1045 mm hoher Wandschrank mit abschließbarer Rolltür. Enthält eine innere quadratische Lochplatte für die Lagerung von Werkzeug.
-  Armadio a parete alto 1045 mm con anta a tamburo chiudibile a chiave. Dispone di un pannello interno con fori quadrati per lo stoccaggio di utensili.
-  Armario mural de 1045 mm de altura con puerta de tambor con cerradura. Incluye panel perforado cuadrado interno para almacenamiento de herramientas.
-  1045 mm hoge wandkast met afsluitbare jaloeziedeur. Bevat een paneel met vierkante perforaties voor de opslag van gereedschap.

WUTB-060

H 1045, W 600, D 300mm

WUTB-090

H 1045, W 900, D 300mm

WUTB-120

H 1045, W 1200, D 300mm



-  1045mm high wall cabinet with lockable tambour door to contain monitor and computer keyboard. Contains sliding keyboard shelf (monitor keyboard and mouse not included).
-  Armoire murale, hauteur 1045 mm pour moniteur et clavier avec porte à rideau verrouillable. Comprend une étagère coulissante pour clavier (livré sans clavier ni souris).
-  1045 m hoher Wandschrank mit abschließbarer Rolltür für Monitor und Computertastatur. Enthält Tastatur-Schublade auf Schienen (Monitor, Tastatur und Maus nicht enthalten).
-  Armadio a parete alto 1045 mm con anta a tamburo chiudibile a chiave per contenere monitor e tastiera per computer. Dispone di un ripiano per tastiera scorrevole (tastiera per monitor e mouse non inclusi).
-  Armario mural de 1045 mm de altura con puerta de tambor con cerradura para alojar el monitor y el teclado del ordenador. Incluye estante deslizante para teclado (monitor, teclado y ratón no incluidos).
-  1045 mm hoge wandkast met afsluitbare jaloeziedeur voor het opbergen van een monitor en computertoetsenbord. Bevat een schuiflade voor een toetsenbord (monitor, toetsenbord en muis niet inbegrepen.)

WUTBC-060

H 1045, W 600, D 300mm

Vertical tool storage cabinet

Armoire de rangement verticale
Vertikalen Werkzeugschrank
Armadio verticale per lo stoccaggio degli attrezzi
Armario de almacenamiento de herramientas vertical
Verticale kast voor opslag van gereedschap



-  Vertical tool storage cabinet with double locking doors and internal peg panel.
-  Armoire de rangement verticale pour outils avec deux portes verrouillables et panneau intérieur perforés.
-  Vertikalen Werkzeugschrank mit Doppelflügeltüren und Lochplatten innen.
-  Armadio verticale per lo stoccaggio degli attrezzi con doppie ante chiudibili a chiave e pannelli interni con fori quadrati
-  Armario de almacenamiento de herramientas vertical con puertas de doble cierre con paneles perforados internos.
-  Verticale kast voor opslag van gereedschap worden geleverd met afsluitbare dubbele deuren en binnenin geperforeerde panelen.

DUS-090

H 1045, W 900, D 175mm

Tall wall cabinet

Armoire murales hautes
Hohem Wandschrank
Alta Armadio a muro
Armario alto
Hoge wandkast



-  1045mm high wall cabinet with lockable double doors. Includes 2 x adjustable inner shelves. (Attached to backstraps)
-  Armoire murales hautes avec portes doubles. Verrouillable, dotée de 2 tablettes ajustables. (Attachés aux supports verticaux)
-  Hohem Wandschrank mit abschließbare Doppeltüren. Mit 2 verstellbaren Einlegeböden. (Wird an vertikalen Stützen befestigt)
-  Alta Armadio a muro con ante doppie a battente. Chiudibile a chiave, con 2 ripiani regolabili. (Attaccare alle supporti verticali)
-  Armario alto con dos puertas bisagra. Bloqueable, con 2 repisas ajustables. (Fijar a soportes verticales)
-  Hoge wandkast met dubbele scharnierdeuren Vergrendelbaar, met 2 instelbare legplanken. (Op Vertikale Steunen)

WDU-120

H 1045, W 1200, D 600mm

WDU-090

H 1045, W 900, D 600mm

Tall baseless cabinet

Armoires de rangement sans base
Hoher Schrank ohne Boden
Mobile alto senza base
Armario alto sin base
Hoge zonder sokkel cabinet



 1045mm high baseless cabinet with 'tambour' roller shutter door. Includes 1 x adjustable inner shelf.

*Additional LED light can be included under adjustable inner shelf.
(Removable support bar also supplied)

 Armoire de hauteur sans base de 1045 mm avec une porte de fermeture de rideau. Inclut 1 x tablette intérieure réglable.

*Une lumière LED supplémentaire peut être incluse sous une étagère intérieure réglable.
(Barre de support amovible également fournie)

 Hoge zonder sokkel cabinet 1045 mm hoher Schrank mit Rolltor ohne Boden. Inklusive 1 x verstellbare Innenablage.

*Zusätzliche LED-Leuchten können unter der verstellbaren Innenablage angebracht werden.
(Abnehmbare Haltestange wird ebenfalls mitgeliefert)

 Armadio alto 1045 mm senza base con anta avvolgibile "tamburo". Include 1 ripiano interno regolabile.

*La luce a LED aggiuntiva può essere inclusa sotto il ripiano interno regolabile.
(Fornita anche una barra di supporto rimovibile)

 Armario de 1045 mm de altura sin una base que incluye una puerta de persiana enrollable "tambor". Incluye 1 x estante interior ajustable.

*Se puede incluir luz LED adicional debajo del estante interior ajustable.
(Barra de soporte extraíble también incluida)

 Kast van 1045 mm hoog zonder sokkel inclusief rolluikdeur. Inclusief 1 x verstelbare binnenplank.

*Extra LED-licht kan worden opgenomen onder verstelbare binnenplank.
(Afneembare steunbalk ook meegeleverd)

WUTB-121

H 1045, W 1200, D 600mm



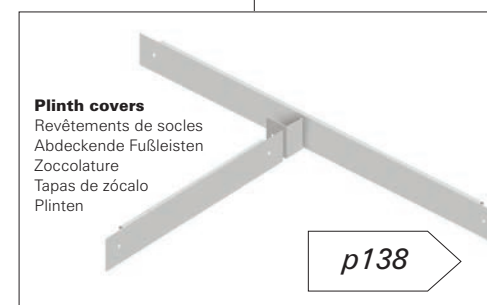
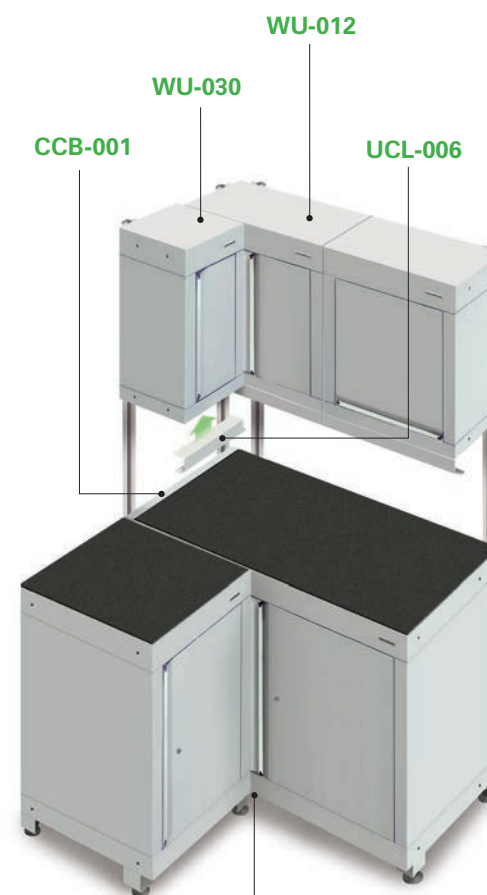

Corner solution

Solution d'angle
Ecklösung
Soluzione angolare
Solución de esquina
Hoekoplossing





 Special products to join cabinets around a corner.

 Produits spécifiques à l'installation d'armoires dans des angles.

 Spezialprodukte, um Schränke in einer Ecke zu verbinden.

 Prodotti speciali per sistemare gli armadietti in un angolo.

 Productos especiales para unir armarios alrededor de una esquina.

 Speciale producten voor hoekaansluiting tussen kasten.

WU-012

600mm wide cabinet with double doors.
Armoire murale largeur 600mm avec double ouverture
600mm breiter Wandschrank mit Doppeltüren
Armadietto da parete largo 600mm con ante doppie
Armario de pared de 600mm de ancho con puertas dobles
600mm wandkast met dubbele deuren



WU-030

300mm wide wall cabinet
Armoire murale largeur 300mm
300mm breiter Wandschrank
Armadietto da parete largo 300mm
Armario de pared de 300mm de ancho
300mm wandkasten



UCL-005 / UCL-006

Angled pelmet for WU-030
Rampe d'angle pour modèle WD-030
Abgewinkelte Blende für WD-030
Mantovana angolare per WD-030
Plato de cortina en ángulo para WD-030
Rechthoekige lijst voor WD-030



CCB-001

Corner conversion brackets (x2)
Support pour armoire d'angle (x2)
Klammern zur Einfassung in Ecken (x2)
Profili di conversione degli angoli (x2)
Soportes de esquina (x2)
Hoekbeugels (x2)



Under-cabinet keyboard trays

Plateaux pour clavier sous l'armoire
 Unterschrank-Tastatur-Schubladen
 Ripiani per tastiera da posizionare sotto l'armadio
 Bandejas de teclado bajo el armario
 Plateaus voor toetsenbord onder kast.



KBS-061 W 600mm

-  Sliding keyboard tray to fit beneath 600mm wide wall cabinets. Tray area 480 x 200mm to accommodate keyboard only.
-  Plateau coulissant pour clavier conçu pour s'intégrer sous les armoires murales de 600mm de large. Surface du plateau de 480 x 200mm pour accueillir seulement le clavier.
-  Tastatur-Schublade auf Schienen, passt unter 600mm breite Wandschränke. Fläche der Lade 480 x 200mm, zur Unterbringung der Tastatur.
-  Ripiano scorrevole da posizionare sotto armadi a muro larghi 600mm. Superficie del ripiano di 480 x 200mm per alloggiare solo la tastiera.
-  Bandeja de teclado deslizante para instalar bajo los armarios de muro de 600mm de ancho. Superficie de la bandeja de 480 x 200mm para colocar sólo un teclado.
-  Uitschuifplateau voor toetsenbord voor onder wandkasten 600mm. Plateau 480 x 200mm alleen voor toetsenbord.



KBS-091 W 780mm

-  Sliding keyboard tray to fit beneath 900 or 1200mm wide wall cabinets. Tray area 660 x 200mm to accommodate keyboard and mouse. Can be fitted on left or right.
-  Plateau coulissant pour clavier conçu pour s'intégrer sous les armoires murales de 900 ou 1200mm de large. Surface du plateau de 660 x 200mm pour accueillir le clavier et la souris. Peut être installé à gauche ou à droite.
-  Gleitende Tastatur-Schublade, passt unter 900 oder 1200mm breite Wandschränke. Fläche der Lade 660 x 200mm, um Tastatur und Maus aufzunehmen. Links oder rechts anpassbar.
-  Ripiano scorrevole da posizionare sotto armadi a muro larghi 900 o 1200mm. Superficie del ripiano di 660 x 200mm per alloggiare tastiera e mouse. Si può montare a sinistra o a destra.
-  Bandeja de teclado deslizante para instalar bajo los armarios de muro de 900 o 1200mm de ancho. Superficie de la bandeja de 660 x 200mm para colocar un teclado y el ratón. Se puede instalar a la izquierda o la derecha.
-  Uitschuifplateau voor toetsenbord voor onder wandkasten 900 of 1200mm. Plateau 660 x 200mm voor toetsenbord en muis. Kan links of rechts worden aangebracht.

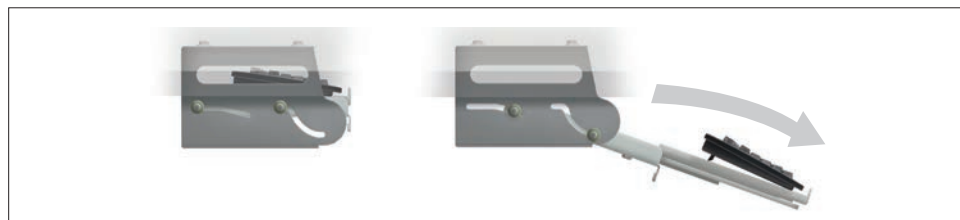







Under-cabinet LED lighting

Éclairage à LED sous armoire
 LED-Unterschrankbeleuchtung
 Illuminazione inferiore a LED
 Iluminación de led para debajo del armario
 LED-verlichting onder kasten



- UCL-120 W 1200mm**
- UCL-090 W 900mm**
- UCL-060 W 600mm**



-  Under-cabinet lighting kit with strip LED lamps behind metal pelmet. Includes interconnecting cables and individual on/off switches.
-  Kit d'éclairage sous armoire à rampes à LED derrière un bandeau métallique. Les câbles d'interconnexion et interrupteurs individuels sont compris dans le kit.
-  Unterschrankbeleuchtungs-Kit mit LED-Leuchte hinter Metallblende. Umfasst Verbindungskabel und individuelle Ein/Aus-Schalter.
-  Kit di illuminazione inferiore con striscia di lampade a LED poste dietro la mantovana metallica. Include i cavi di collegamento e i singoli interruttori di accensione e spegnimento.
-  Kit de iluminación para debajo del armario con luces de led detrás de galería metálica. Incluye cables de conexión e interruptores individuales de conexión/desconexión.
-  Verlichtingsset voor montage onder kasten met een LED-strook achter een metalen sierlijst. Inclusief bevestigingskabels en individuele aan/uit-schakelaars.

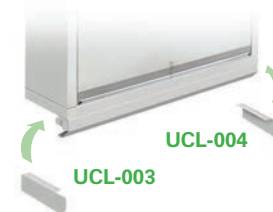

Left or right hand end finishing plates pelmet plates.
 Rampes d'éclairage avec extrémité à gauche ou à droite.
 Links- oder rechtsseitiger Abschluss der Blendenleisten.
 Piastra per mantovana con rifinitura finale a sinistra o a destra.
 Platos cortina que terminan a la izquierda o la derecha.
 Linker of rechter eindstuk lijsten.

- UCL-003 Left**
- UCL-004 Right**



Front pelmets only (no lighting)
 Rampe avant uniquement (sans éclairage)
 Nur Frontblenden (keine Beleuchtung)
 Solo mantovane frontali (senza illuminazione)
 Galerías delanteras únicamente (sin iluminación)
 Alleen lijsten aan voorzijde (geen verlichting)

- UCP-120 1200mm**
- UCP-090 900mm**
- UCP-060 600mm**
- UCP-030 300mm**



Cable connector and plug.
 Câble de connexion et prise.
 Kabelverbindung und Stecker.
 Cavo di collegamento e spina.
 Cable de conexión y enchufe.
 Kabelverbinder en plug.

- UCL-001 UK**
- UCL-002 Euro**

Back panels and fittings

Panneaux arrières et fixations

Rückpaneele und Anschlüsse

Pannelli posteriori e attrezzature

Paneles traseros y fijaciones

Achterpanelen en bekleding





Upper back panels
 Panneaux arrière supérieurs
 Obere Rückpaneele
 Pannelli posteriori alti
 Paneles traseros superiores
 Hoge achterpanelen

Back panels
 Panneaux arrières
 Rückpaneele
 Pannelli posteriori
 Paneles traseros
 Achterpanelen

Back panels

Available in a range of sizes and types to allow maximum flexibility for positioning storage bins, shelves, hooks, and electrical fittings beneath the wall cabinets. The panels can be fitted directly to the wall or attached to backstraps.

Panneaux arrières

Disponibles dans diverses tailles et sortes pour permettre davantage de flexibilité pour positionner les poubelles, les étagères, les crochets et les raccordements électriques sous les armoires murales. Les panneaux peuvent être fixés directement au mur ou attachés aux colliers.

Rückpaneele

In einer Reihe von Größen und Typen erhältlich, die eine größtmögliche Flexibilität für die Positionierung von Behältern, Einlegeböden, Haken und elektrischen Anschlüssen unterhalb der Wandschränke ermöglichen. Die Paneele können direkt an die Wand angebracht oder an den Backstraps befestigt werden.

Pannelli posteriori

Disponibili in una vasta gamma di dimensioni e tipi per permettere la massima flessibilità per posizionare pattumiere, ripiani, ganci e apparecchiature elettriche sotto gli armadi a muro. I pannelli si possono fissare direttamente al muro o attaccare alle cinghie posteriori.

Paneles traseros

Disponible en una amplia gama de tamaños y tipos para permitir una flexibilidad máxima en el posicionamiento de recipientes, repisas, ganchos y fijaciones eléctricas bajo los armarios de muro. Los paneles se pueden fijar directamente a la pared o fijar a backstraps.

Achterpanelen

Beschikbaar in meerdere maten en soorten voor plaatsen van afvalbakken, legplanken, haken en fittingen naast wandkasten. De panelen kunnen rechtstreeks tegen de wand worden bevestigd of op strippen worden vastgezet.



Blank upper back panels

- Blank upper back panels – designed to create a continuous visual effect between wall cabinets.
- Panneaux arrière supérieurs neutres – conçus pour créer un effet visuel continu entre les armoires murales.
- Obere Blanko-Rückpaneele – zur Schaffung einer kontinuierlichen Optik zwischen den Wandschränken.
- Pannelli posteriori alti vuoti – progettati per creare un effetto visivo continuo tra gli armadi a muro.
- Paneles traseros superiores en blanco, diseñados para crear un efecto visual continuo entre armarios murales.
- Neutrale hoge achterpanelen – ontworpen om een doorlopend visueel effect te creëren tussen de wandkasten.

	H	W
WPB-002	1045	600mm
WPB-091	1045	900mm
WPB-121	1045	1200mm
UBP-001	600	600mm
UBP-090	600	900mm
UBP-120	600	1200mm



Blank back panels

- Blank back panels – ideal for corporate logos.
- Panneaux arrières neutres, parfaits pour les logos d'entreprise.
- Blanko-Rückpaneele – ideal für Firmenlogos.
- Pannelli posteriori vuoti – ideali per luogi aziendali.
- Paneles traseros en blanco (ideal para logotipos corporativos).
- Neutrale achterpanelen – ideaal voor bedrijfslogo's.

	H	W
BP-001	440	600mm
BP-090	440	900mm
BP-120	440	1200mm
BP-060300	300	600mm
BP-090300	300	900mm
BP-120300	300	1200mm
BP-060160	160	600mm
BP-090160	160	900mm
BP-120160	160	1200mm



Stainless steel back panels

- Stainless steel blank back panels.
- Panneaux arrières neutres en acier inoxydable.
- Blanko-Rückpaneele aus Edelstahl.
- Pannelli posteriori vuoti di acciaio inossidabile.
- Paneles traseros en blanco de acero inoxidable.
- Roestvrij stalen blanke achterpanelen.

	H	W
SK-001	440	600mm
SK-090	440	900mm
SK-120	440	1200mm
SK-060300	300	600mm
SK-090300	300	900mm
SK-120300	300	1200mm
SK-060160	160	600mm
SK-090160	160	900mm
SK-120160	160	1200mm

Square peg panels and accessories

Panneaux perforés et accessoires
Lochplatten und Zubehör
Pannelli forati e accessori
Paneles perforados y accesorios
Geperforeerde panelen en accessoires

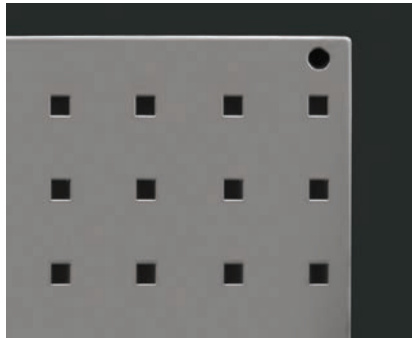

Square peg back panels

- Peg panels – square holed panels for hook system.
- Panneaux perforés, panneaux munis de trous carrés pour un système de crochets.
- Lochplatten – Paneelen mit quadratischen Löchern für Hakensysteme.
- Pannelli forati – Pannelli forati quadrati per sistema a ganci.
- Paneles perforados - Paneles con agujeros cuadrados para un sistema de enganche.
- Geperforeerde panelen - Panelen met vierkanten gaten voor haaksysteem.

	H	W
SQ-060	440	600mm
SQ-090	440	900mm
SQ-120	440	1200mm



Accessories for peg panels

- Hooks to fit to square peg system on back panels.
- Crochets adaptés au système de perforations carrées sur les panneaux arrières.
- Haken, die in das quadratische Lochlattensystem an den Rückpaneelen passen.
- Ganci da fissare al pannello perforato quadrato sui pannelli posteriori.
- Ganchos para fijar al sistema de perforaciones cuadradas en paneles traseros.
- Haken voor systeem met vierkanten gaten op achterpanelen.

VSDSQR-001 = 470 pieces

Hook multipack for VSD cabinets containing 470 hooks
Emballage groupé de crochets pour armoires VSD contenant 470 crochets
Mehrstückpackung mit Haken für VSD-Schränke, enthält 470 Haken
Sistema di ganci per armadi con meccanismo per il cambio della velocità contenenti 470 ganci
Paquete múltiple de gancho para armarios VSD. Contiene 470 ganchos
Hoek multipak voor VSD kasten met 470 haken

- SQR-001** x 10 (= 50)
- SQR-002** x 10 (= 50)
- SQR-005** x 10 (= 50)
- SQR-006** x 10 (= 50)
- SQR-007** x 10 (= 50)
- SQR-008** x 10 (= 30)
- SQR-009** x 10 (= 30)
- SQR-010** x 10 (= 60)
- SQR-011** x 10 (= 60)
- SQR-012** x 10 (= 40)



SQR-001

60mm single hooks (pack of 5)
60mm crochets à une branche (pack de 5)
60mm lanen Einzelhaken (Packung mit 5)
60mm ganci a punta lunghi singoli (Scatola da 5)
60mm ganchos con un diente de cables (Paquete de 5)
60mm enkelvoudige tandhaken (Set 5)



SQR-002

90mm single hooks (pack of 5)
90mm crochets à une branche (pack de 5)
90mm lanen Einzelhaken (Packung mit 5)
90mm ganci a punta lunghi singoli (Scatola da 5)
90mm ganchos con un diente de cables (Paquete de 5)
90mm enkelvoudige tandhaken (Set 5)

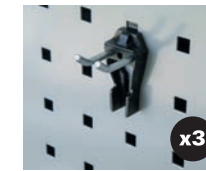

SQR-003

30mm double hooks (pack of 3)
30mm crochets à double branche (pack de 3)
30mm lanen Doppelhaken (Packung mit 3)
30mm ganci a punta lunghi doppi (Scatola da 3)
30mm ganchos con doble diente de cables (Paquete de 3)
30mm dubbele tandhaken (Set 3)



SQR-004

60mm double hooks (pack of 3)
60mm crochets à double branche (pack de 3)
60mm lanen Doppelhaken (Packung mit 3)
60mm ganci a punta lunghi doppi (Scatola da 3)
60mm ganchos con doble diente de cables (Paquete de 3)
60mm dubbele tandhaken (Set 3)



SQR-005

25mm single hooks (pack of 5)
25mm crochets à une branche (pack de 5)
25mm lanen Einzelhaken (Packung mit 5)
25mm ganci a punta lunghi singoli (Scatola da 5)
25mm ganchos con un diente de cables (Paquete de 5)
25mm enkelvoudige tandhaken (Set 5)

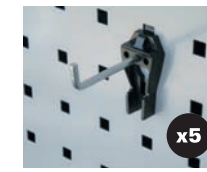

SQR-006

50mm single hooks (pack of 5)
50mm crochets à une branche (pack de 5)
50mm lanen Einzelhaken (Packung mit 5)
50mm ganci a punta lunghi singoli (Scatola da 5)
50mm ganchos con un diente de cables (Paquete de 5)
50mm enkelvoudige tandhaken (Set 5)



SQR-007

75mm single hooks (pack of 5)
75mm crochets à une branche (pack de 5)
75mm lanen Einzelhaken (Packung mit 5)
75mm ganci a punta lunghi singoli (Scatola da 5)
75mm ganchos con un diente de cables (Paquete de 5)
75mm enkelvoudige tandhaken (Set 5)



SQR-008

75mm hammer holders (pack of 3)
75mm porte-marteaux (pack de 3)
75mm Hammerhalter (Packung mit 3)
75mm Supporto per martello (Scatola da 3)
75mm Soporte de martillo (Paquete de 3)
75mm Hamerhouder (Set 3)



SQR-009

50mm pliers holders (pack of 3)
50mm porte-tenailles (pack de 3)
50mm Zangenhalter (Packung mit 3)
50mm Supporto per pinze (Scatola da 3)
50mm Soporte de alicates (Paquete de 3)
50mm Tanghouder (Set 3)



SQR-010

12mm spring clips (pack of 6)
12mm colliers à ressorts (pack de 6)
12mm federnde Klemmen (Packung mit 6)
12mm mollette di fissaggio (Scatola da 6)
12mm ganchos muelles (Paquete de 6)
12mm borgveren (Set 6)

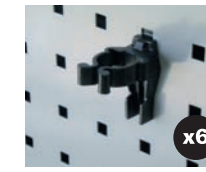

SQR-011

24mm spring clips (pack of 6)
24mm colliers à ressorts (pack de 6)
24mm federnde Klemmen (Packung mit 6)
24mm mollette di fissaggio (Scatola da 6)
24mm ganchos muelles (Paquete de 6)
24mm borgveren (Set 6)



SQR-012

60mm drill holders (pack of 4)
60mm porte-mèches (pack de 4)
60mm Bohrerhalter (Packung mit 4)
60mm Supporto per trapano (Scatola da 4)
60mm Soporte de taladro (Paquete de 4)
60mm Boorhouder (Set 4)

Louvre panels and accessories

Panneaux à claire-voie et accessoires
 Paneele mit Lüftungsöffnungen und Zubehör
 Pannelli a stecche verticali e accessori
 Paneles persiana y accesorios
 Louvre panelen en accessoires



Louvre back panels

-  Louvre panels – for attaching bins or aerosol shelves.
-  Panneaux à claire-voie, pour attacher les poubelles ou les étagères à aérosols.
-  Paneele mit Lüftungsöffnungen – Zum Befestigen von Behältern oder Spraydosenregalen.
-  Pannelli a stecche verticali – Per attaccare pattumiere o ripiani per aerosol.
-  Paneles persiana - Para fijar recipientes o repisas de aerosoles.
-  Louvre panelen - Voor bevestiging van afvalbakken en opbergplanken voor spuitbussen.

	H	W
LU-011	440	600mm
LU-090	440	900mm
LU-012	440	1200mm



Storage bins

-  Blue component storage bins to fit to louvre panel, available in 5 sizes.
-  Poubelles de stockages bleu pour les déchets adaptées au panneau à claire-voie, disponibles en 5 tailles.
-  Blaue Vorratsbehälter für Komponenten passend zur Paneele mit Lüftungsöffnungen, in 5 Größen erhältlich.
-  Scatole di immagazzinaggio blu, per adattarsi ad un pannello a stecche verticali disponibili in 5 dimensioni.
-  Recipiente de almacenamiento Azul a fijar al panel cortina, disponible en 5 dimensiones.
-  Blauwe voorraadbak voor onderdelen bestemd voor louvre paneel, leverbaar in 5 maten.

	H	W	D
BOX-001	49	106	106mm
BOX-002	76	106	187mm
BOX-003	127	140	205mm
BOX-004	179	210	375mm
BOX-004D	179	415	370mm

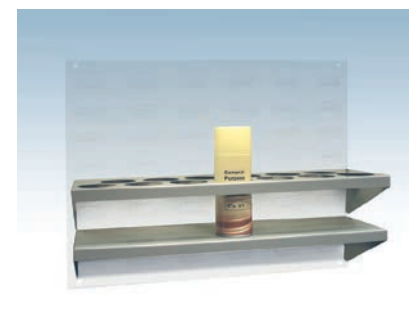





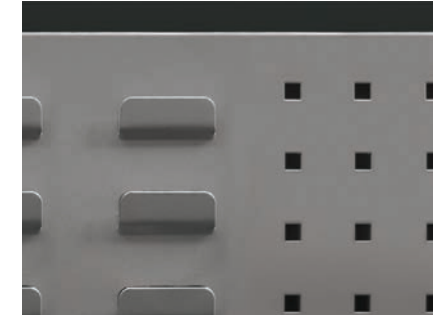

Aerosol shelf SH-004

-  600mm wide aerosol shelf to fit to louvre panel. Can store up to 13 cans.
-  Étagère à aérosols de 600mm de large conçue pour s'adapter au panneau à claire-voie. Permet de stocker jusqu'à 13 bidons.
-  600mm breites Spraydosenregal passend zu Paneele mit Lüftungsöffnungen. Kann bis zu 13 Dosen aufnehmen.
-  Ripiano per aerosol largo 600mm da fissare al pannello a stecche verticali. Può contenere fino a 13 recipienti.
-  Repisa aerosol de 600mm de ancho para fijar al panel de cortina. Puede contener hasta 13 botes.
-  Opbergplank voor spuitbussen 600mm voor in louvre paneel. Ruimte voor 13 spuitbussen.



Hybrid back panel

LPS-120 H 440, W 1200mm

-  Hybrid panels with louvre and peg.
-  Panneaux hybrides, avec claire-voie et perforation.
-  Hybridpaneele - mit Lüftungsöffnungen und quadratischen Löchern für Hakensysteme.
-  Pannelli ibridi – con pannelli a stecche verticali e pannelli forati.
-  Paneles híbridos - de cortina y perforados.
-  Hybride panelen - met louvre en gaten.

Shelf for back panels

Étagère pour panneaux arrières
Regal für Rückpaneele
Ripiano per pannelli posteriori
Repisa para paneles traseros
Plank voor plateaus voor achterpanelen



USH-120 W 1200mm
USH-090 W 900mm
USH-060 W 600mm



Electrical controls for back panels

Commandes électriques pour panneaux arrières
Elektrik für Rückpaneele
Comandi elettrici per pannelli posteriori
Controles eléctricos para paneles traseros
Elektrische bediening voor achterpanelen

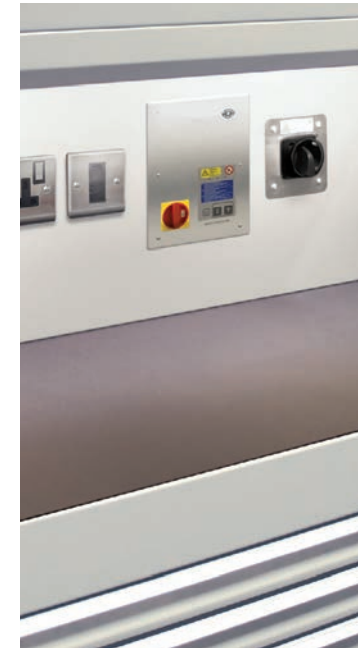

-  Blank and stainless steel back panels can be supplied with integrated sockets, switches and controls in a variety of combinations. *Please contact us for details.*
-  Nous pouvons vous fournir des panneaux arrières neutres en acier inoxydable avec des prises intégrées, des commutateurs et des commandes électriques dans diverses combinaisons. *Merci de nous contacter pour de plus amples détails.*
-  Blanko- und Edelstahl-Rückpaneele können mit integrierten Steckdosen, Schaltern und Bedienelemente in zahlreichen Kombinationen geliefert werden. *Bitte kontaktieren Sie uns für Einzelheiten.*
-  I pannelli posteriori vuoti e di acciaio inossidabile si possono fornire con prese integrate, interruttori e comandi in un'ampia varietà di combinazioni. *Contattarci per ulteriori dettagli.*
-  Los paneles traseros de acero inoxidable y en blanco se pueden suministrar con enchufes integrados, interruptores y controles en diferentes combinaciones. *Por favor contáctenos si desea más informaciones.*
-  Blanke en roestvrijstalen achterpanelen kunnen worden geleverd met geïntegreerde fittingen, schakelaars en bedieningen in verschillende combinaties. *Voor meer informatie gelieve contact met ons op te nemen.*



Single power sockets

Prises électriques simples
Einzelsteckdose
Presa singola
Enchufes de alimentación simples
Enkelvoudige wandcontactdoos



Data sockets

Prises de données
Daten-Sockets
Prese dati
Enchufes de datos
Gegevenssockets



Light sockets

Prises pour l'éclairage
Lichtschalter
Prese per luce
Enchufes de alumbrado
Lampfittingen



Double power sockets

Prises électriques doubles
Doppelsteckdose
Presa doppia
Enchufes de alimentación dobles
Dubbele wandcontactdoos



Isolator switch

Interrupteur
Ausschalter
Interruttore
Interruptor de corte
Schakelaar



Lift lower/raiser controls

Commandes d'abaissement/d'élévation
Bedienelemente zum Heben/Senken der Hebebühne
Comandi per abbassare/sollevarre il ponte elevatore
Controles subida/bajada elevadores
Liftbediening

Backstraps

Supports verticaux
Vertikale Stützen
Supporti verticali
Soportes verticales
Vertikale Steunen



 Vertical supports (backstraps) are required for all freestanding installations and recommended where walls are non-structural or uneven. Set comprises of two backstraps and connects wall cabinet and back panel to base cabinet.

 Des supports verticaux (colliers) sont nécessaires pour toutes les installations autonomes et recommandés lorsque les murs ne sont pas porteurs ou s'ils sont irréguliers. L'ensemble comprend deux colliers et raccorde l'armoire murale et le panneau arrière au meuble de rangement.

 Vertikale Stützen (Backstraps) sind für alle freistehenden Installationen notwendig und werden empfohlen, wenn es sich um nicht tragende oder unebene Wände handelt. Ein Satz enthält zwei Backstraps und verbindet den Wandschrank und das Rückpaneel mit dem Unterschrank.

 I supporti verticali (cinghie posteriori) sono necessari per tutte le installazioni autoreggenti e si raccomandano dove i muri non sono strutturali o sono irregolari. Il set comprende due cinghie posteriori e collega l'armadio a muro e il pannello posteriore con l'armadio basso.

 Se requieren soportes verticales (Backstraps) para todas las instalaciones independientes y se recomiendan donde las paredes no están a escuadra. El conjunto se compone de dos backstraps y conecta el armario de muro y el panel trasero al armario de base.

 Verticale steunen (strips) zijn vereist voor alle vrijstaande installaties en aanbevolen voor niet-structurele of ongelijke wanden. Set van twee strippen die de wandkast en het achterpaneel aan de onderkast bevestigen.

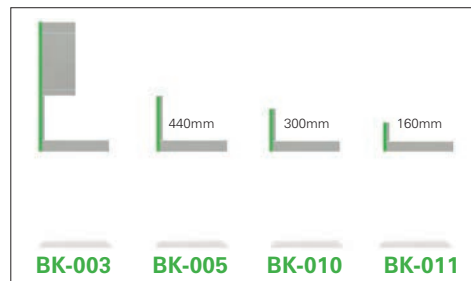



Upstands

Panneaux arrières
Blanko-Rückpaneel
Pannello posteriore
Paneles traseros
Blank achterpaneel

 Upstand to bolt directly to the back of base cabinets.

 Panneaux arrières neutres qui les panneaux peuvent être fixés directement au meuble de rangement.

 Blanko-Rückplatte die geschraubt direkt die werden Werkzeugschränke.

 Pannello posteriore vuoto che può essere fissato direttamente ad una armadio per lo stoccaggio degli utensili.

 Paneles traseros en blanco que se pueden atornillar directamente a Armarios de almacenamiento de herramientas.

 Blank achterpaneel die kunnen worden bevestigd aan een opbergkast voor gereedschap.



Epoxy coated steel

Acier revêtu d'époxy
Epoxidbeschichteter Stahl
Acciaio con rivestimento epossidico
Acero recubierto de epoxy
Epoxy gecoat staal

	H	W
BP-060050	50	600mm
BP-090050	50	900mm
BP-120050	50	1200mm
BP-060161	160	600mm
BP-090161	160	900mm
BP-120161	160	1200mm



Stainless steel

Acier inoxydable
Edelstahl
Acciaio inossidabile
Acero inoxidable
Roestvrij staal

	H	W
SK-060050	50	600mm
SK-090050	50	900mm
SK-120050	50	1200mm

Socket and control trunking system

Plinthe électrique pour prises et commandes
 Verteilersystem für Steckdosen und Steuerungen
 Sistema di prese e canalette per comandi
 Sistema de canalización de controles y tomas de corriente
 Kabelgootsysteem voor stopcontacten en schakelaars



-  The trunking system is an alternative to back panels, allowing sockets and controls to be mounted at a lower level, and angled at 45° for convenient use. Trunking sections are available at the standard cabinet widths of 1200, 900 and 600mm, and include an overlap panel for continuous runs and can be supplied with or without panels for controls.
-  La plinthe électrique est une alternative aux panneaux arrière, permettant de monter les prises et commandes à un niveau plus bas et de les incliner à 45 ° pour une utilisation pratique. Les sections de plinthe sont disponibles dans les dimensions standard des meubles de rangement de 1 200 mm, 900 mm et 600 mm, comprennent un panneau de recouvrement pour un fonctionnement continu, et sont fournies avec ou sans les panneaux de commandes..
-  Das Verteilersystem ist eine Alternative zu herkömmlichen Rückwänden. Es ermöglicht die Montage von Steckdosen und Steuerungen auf niedrigerer Höhe und im Winkel von 45°, sodass diese leicht zugänglich sind. Die Verteilerabschnitte sind in den Standard-Schrankbreiten von 1200, 900 und 600mm erhältlich. Sie umfassen ein Überlappungselement für eine durchgehende Verteilerführung und können mit oder ohne Steuerungselemente geliefert werden.
-  Il sistema di canalette è un'alternativa ai pannelli posteriori che consente di montare le prese e i comandi a un livello inferiore e con angoli di 45° facilitandone l'uso. Le sezioni di canalette sono disponibili per gli armadi standard da 1200, 900 e 600 mm e comprendono un pannello sovrapposto per il funzionamento continuo; inoltre possono essere provviste o meno di pannelli per i comandi.
-  El sistema de canalización es una alternativa a los paneles traseros, que permite montar tomas de corriente y controles en un nivel más bajo, y con un ángulo de 45° para un uso cómodo. Las secciones de canalización se encuentran disponibles con las anchuras de armario estándar de 1200, 900 y 600 mm. Asimismo, incluyen un panel de superposición para línea continua y pueden suministrarse con o sin paneles para controles.
-  Het kabelgootsysteem is een alternatief voor achterpanelen, waardoor contactdozen en schakelaars lager en onder een hoek van 45° kunnen worden gemonteerd voor meer gebruiksgemak. Kabelgootsecties zijn beschikbaar met de standaard kastbreedtes van 1200, 900 en 600 mm, en hebben een overlappaneel voor doorlopende montages en kunnen worden geleverd met of zonder schakelaarpanelen.

Blank trunking sections *

Sections de plinthe vierges
 Geschlossene Verteilerabschnitte
 Sezioni canalette vuote
 Secciones de canalización vacías
 Lege kabelgootsecties



TRU-060
600mm



TRU-090
900mm



TRU-120
1200mm

Trunking sections with electrical provision *

Sections de plinthe avec alimentation électrique
 Verteilerabschnitte mit Steckdosenvorrichtung
 Sezioni canalette con predisposizione elettrica
 Secciones de canalización con hueco para cables eléctricos
 Kabelgootsecties met elektrische voorziening



TRUE-060
600mm



TRUE-090
900mm



TRUE-120
1200mm

Socket Panels

Panneaux de prises (D'autres pays sont disponibles)
 Steckdosenelemente (andere Länder verfügbar)
 Pannelli prese (Altri paesi sono disponibili)
 Paneles de tomas de corriente (otros países están disponibles)
 Contactdoospanelen (andere landen zijn beschikbaar)



UKP-001



EUROP-001

* End plate included

Comprend embout
 Inklusive Abschlusselement
 Include piastrina finale
 Incluye placa del extremo
 Eindplaat inbegrepen







Workbenches and Trolleys

Postes de travail et chariots
Werkbänke und Transportwagen
Banchi di lavoro e carrelli
Bancos de trabajo y carros
Werkbanken en rolwagens



Standard workbenches

Postes de travail standard
 Standard-Werkbänke
 Banchi standard
 Bancos de trabajo estándar
 Standaard werkbanken

-  Standard workbenches
 - Height 950mm – standard.
 - Height 850mm – recommended for use with vice.
-  Postes de travail standard
 - Hauteur 950mm – standard.
 - Hauteur 850mm – recommandé pour l'utilisation d'un étau.
-  Standard- Werkbänke
 - Höhe 950mm – standardmäßig.
 - Höhe 850mm – empfohlen für die Verwendung mit Schraubstock.
-  Banco standard
 - Altezza 950mm - standard.
 - Altezza 850mm – raccomandati per l'uso con morse.
-  Banco de trabajo estándar
 - Altura 950mm - estándar.
 - Altura 850mm – recomendada para el uso con tornillo.
-  Standaard werkbank
 - Hoogte 950mm - standaard.
 - Hoogte 850mm - aanbevolen voor gebruik met bankschroeven.



	H	W	D
WB-001	850	1200	600mm
WB-003	950	1200	600mm
WB-090	850	900	600mm
WB-009	950	900	600mm



Self-assembly
 Auto-assemblage
 Selbstmontage
 Autoassemblaggio
 Automontable
 Zelfopbouw



	H	W	D
WB-002	850	1200	600mm
WB-007	950	1200	600mm
WB-092	950	900	600mm



Workbench vice VIC-003



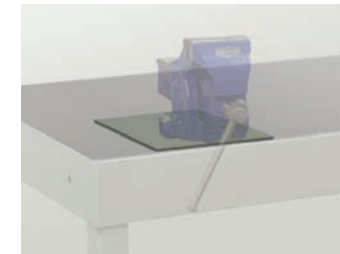



Bench vice – 4" Record No.3.
 Étau – 4" Record No.3.
 Schraubstock – 4" Record No.3.
 Morsa da banco – 4" Record No.3.
 Vicio de banco – 4" Record No.3.
 Bankschroef – 4" Record No.3.



Workbench vice plate VIC-001

Vice-plate
 Plaque d'étau
 Schraubstock-platte
 Piastra morsa
 Placa tornillo
 Bankschroefplaat

Workbench back panels

-  Lower back panel for standard workbench.
-  Panneau inférieur arrière pour banc de montage de 950mm de hauteur.
-  Unteres Rückpaneel für 950mm hohe Werkbank.
-  Pannello posteriore inferiore per stazione di lavoro alta 950mm.
-  Panel trasero inferior de ancho para banco de trabajo de 950mm de alto.
-  Achterpaneel onder voor 950mm hoge werkbank.



	H	W
WBBP-850	850	1200mm
WBBP-950	950	1200mm
WBBP-900	950	900mm

Heavy-duty workbenches

Postes de travail hautement résistants
 Werkbänke für hohe Beanspruchung
 Banchi resistenti
 Bancos robustos
 Zware werkbanken



	H	W	D
HWB-1228	850	1200	1200mm
HWB-1298	850	1200	900mm
HWB-1598	850	1500	900mm
HWB-122	950	1200	1200mm
HWB-129	950	1200	900mm
HWB-159	950	1500	900mm



	H	W	D
HWB-159C	950	1500	900mm

-  Heavy-duty benches (assembly required). Height 950mm – standard. Height 850mm – recommended for use with vice.
-  Postes de travail hautement résistants (assemblage nécessaire). Hauteur 950mm – standard. Hauteur 850mm – recommandé pour l'utilisation d'un étau.
-  Werkbänke für hohe Beanspruchung (Montage notwendig). Höhe 950mm – standardmäßig. Höhe 850mm – empfohlen für die Verwendung mit Schraubstock.
-  Banchi resistenti (montaggio necessario). Altezza 950mm - standard. Altezza 850mm – raccomandati per l'uso con morse.
-  Bancos robustos (requieren montaje). Altura 950mm - estándar. Altura 850mm – recomendada para el uso con tornillo.
-  Zware werkbanken (zelfopbouw). Hoogte 950mm - standaard. Hoogte 850mm - aanbevolen voor gebruik met bankschroeven.



Self-assembly
 Auto-assemblage
 Selbstmontage
 Autoassemblaggio
 Automontable
 Zelfopbouw

Wall-mounted workbenches



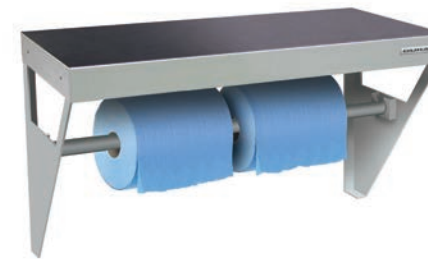



Postes de travail muraux
 Wand montierte Werkbänke
 Banchi di lavoro montato a parete
 Bancos de trabajo de pared
 Werkbank aan de muur bevestigde



WWB-120 W 1200, D 600mm









WWB-060 W 600, D 600mm

-  600/1200mm wide wall-mounted workbench with under-bench holder for rolls of towels. Can hold tubes of minimum 65mm.
-  Postes de travail muraux de 600/1200mm de large avec porte-rouleaux d'essuie-main sous l'établi. Peut contenir des rouleaux de 65mm minimum.
-  600/1200mm Breite, an die Wand montierte Werkbank mit Handtuchrollenhalter unter der Werkbank. Kann Rohre von mindestens 65mm halten.
-  Banco di lavoro largo 600/1200mm, montato a parete, con supporto per rotoli asciugamani. Può reggere tubi di minimo 65mm.
-  Banco de trabajo de montaje mural de 600/1200 mm de anchura con soporte bajo el banco para rollos o toallas. Puede contener tubos de 65mm como mínimo.
-  600/1200mm brede aan de muur bevestigde werkbank met houder voor onderkast voor handdoekrollen. Kan buizen dragen van minimaal 65mm.

Cabinet-mounted towel holder **TOW-001**



-  600mm wide cabinet-mounted holder for rolls of towels.
-  Support pour tenir les rouleaux de serviettes en papier.
-  Halterung für Papierrollen und Handtücher.
-  Staffa di tenere rotoli di tovaglioli di carta.
-  Soporte para sujetar rollos de toallas de papel.
-  Bracket om rollen papier handdoeken te houden.

Folding workbench

Établi pliant permettant
Klappwerkbank
Banco di lavoro pieghevole
Banco de trabajo plegable
Inklapwerkbank





TR-007 H 790, W 1200, D 570mm

 Folding workbench designed to collapse to a compact size to fit underneath bridging units (840 x 285 x 570mm). Fitted with heavy-duty composite worksurface and lockable castors.

 Établi pliant permettant le rangement sous les plaques de pontage (840 x 285 x 570mm). Plan de travail en matériau composite lourd et roulettes de blocage.

 Klappwerkbank, auf kompakte Abmessungen klappbar, sodass sie unter die Verbindungseinheiten passt (840 x 285 x 570mm). Ausgestattet mit Hochleistungs-Arbeitsoberfläche aus Verbundwerkstoff und abschließbaren Rollen.

 Banco di lavoro pieghevole progettato anche per una configurazione più compatta, in modo da essere inserito sotto le unità di collegamento (840 x 285 x 570mm). Dotato di una resistente superficie di lavoro in composito e di ruote orientabili bloccabili.

 Banco de trabajo plegable diseñado para convertirlo a un tamaño compacto y encajarlo debajo de las unidades de unión (840 x 285 x 570mm). Incluye superficie de trabajo robusta de material compuesto y ruedas giratorias bloqueables.

 Inklapwerkbank die tot een compacte afmeting ingeklapt kan worden zodat deze onder overbruggingsstukken past (840 x 285 x 570mm). Uitgerust met robuust composietwerkoppervlak en vergrendelbare wielen.









Under-bench trolley

Chariot sous l'établi
Unterbankwagen
Carrello sotto scrivania
Carro debajo del banco de trabajo
Robuuste rolwagen onder de werkbank



	H	W	D
TR-120	845	1160	570mm
TR-009	845	860	570mm
TR-060	845	560	570mm
TR-061	838	404	434mm

(Designed for BUES-061)







-  Heavy-duty 2 tier trolley designed to fit beneath bridging units (assembly required). Tray style shelves prevent loss of small components. Fitted with lockable castors.
-  Chariot lourd 2 niveaux sous plaques de pontage (livré démonté). Étagères type plateau permettant de prévenir la perte des petites pièces. Roulettes avec blocage.
-  2-Ebenen-Hochleistungswagen, passt unter die Verbindungseinheiten (Montage erforderlich). Facheinlegeböden verhindern, dass kleine Komponenten verloren gehen. Mit abschließbaren Rollen.
-  Resistente carrello a 2 piani, progettato per essere inserito sotto le unità di collegamento (assemblaggio richiesto). Ripiani a vassoio per prevenire la caduta dei piccoli componenti. Dotato di ruote orientabili bloccabili.
-  Banco robusto de 2 niveles diseñado para encajarlo debajo de unidades de unión (precisa montaje). Estantes tipo bandeja para evitar la pérdida de pequeñas piezas. Dispone de ruedas giratorias bloqueables.
-  Robuuste rolwagen met 2 niveaus ontworpen voor plaatsing onder overbruggingsstukken (montage vereist). Plateaus met opstaande rand verhinderen dat kleine onderdelen kwijt raken. Uitgerust met vergrendelbare wielen.

Strip-down cages

Cage verrouillable
Verschließbarer Käfig
Gabbia chiudibile
Jaula bloqueables
Vergrendelbare kast



TR-005
H 1800, W 1000, D 1000mm

-  Lockable cage with four drawers for storing removed vehicles items securely. Supplied with lockable castors.
-  Cage verrouillable avec quatre tiroirs pour ranger en lieu sûr les pièces déposées des véhicules. Fournie avec des roulettes à blocage intégré.
-  Verschließbarer Käfig mit vier Schubladen für die sichere Aufbewahrung von abgebauten Fahrzeugteilen. Wird mit blockierbaren Rollen geliefert.
-  Gabbia chiudibile a chiave con quattro cassetti per lo stoccaggio sicuro degli elementi tolti dai veicoli. Fornita con ruote orientabili bloccabili.
-  Jaula bloqueables con cuatro cajones para almacenar de manera segura elementos de vehículos extraídos. Suministrada con ruedas giratorias bloqueables.
-  Vergrendelbare kast met vier lades voor het veilig opslaan van verwijderde voertuigonderdelen. Wordt geleverd met vergrendelbare wielen.



TR-175
H 1800, W 1000, D 1000mm

-  Lockable cage with 3 shelves for storing removed vehicles items securely. Supplied with lockable castors.
-  Cage verrouillable avec 3 étagères pour ranger en lieu sûr les pièces déposées des véhicules. Fournie avec des roulettes à blocage intégré.
-  Verschließbarer Käfig mit 3 Fachböden für die sichere Aufbewahrung von abgebauten Fahrzeugteilen. Wird mit blockierbaren Rollen geliefert.
-  Gabbia chiudibile a chiave con 3 ripiani per lo stoccaggio sicuro degli elementi tolti dai veicoli. Fornita con ruote orientabili bloccabili.
-  Jaula bloqueables con 3 estantes para almacenar de manera segura elementos de vehículos extraídos. Suministrada con ruedas giratorias bloqueables.
-  Vergrendelbare kast met 3 leg planken voor het veilig opslaan van verwijderde voertuigonderdelen. Wordt geleverd met vergrendelbare wielen.

Under-bench Tool Storage Cabinets and Bridging Units

Meubles de rangement des outils sous l'établi et les unités de pontage

Werkzeugschränke unter der Werkbank und Verbindungseinheiten

Armadi per lo stoccaggio degli utensili da posizionare sotto scrivania e unità di collegamento

Armarios de almacenamiento de herramientas bajo el banco y unidades de unión

Opbergkasten voor gereedschap onder werkbank en overbruggingsstukken

p35-41



Workshop trolleys

Chariots d'atelier
Werkstattwagen
Carrelli per officina
Carros de taller
Werkplaatswagens





Service trolley

TR-001

H 1200, W 1200, D 600mm

 Heavy-duty 4 tier trolley (assembly required). Tray style shelves prevent loss of small components. Fitted with lockable castors and handle.

 Chariot lourd à 4 niveaux (assemblage nécessaire). Les étagères en forme de plateau permettent d'éviter la perte de petits composants. Muni de roulettes avec blocage intégré et d'une poignée.

 Transportwagen mit 4 Ablageböden für hohe Beanspruchung (Montage notwendig). Schubladenähnliche Fächer verhindern das Verlieren kleiner Komponenten. Mit blockierbaren Rollen und Handgriff versehen.

 Carrello a 4 piani resistente (montaggio necessario). I ripiani a vassoio prevengono la caduta degli attrezzi. Dotato di ruote orientabili e manico.

 Banco robusto 4 niveles (requiere montaje). Repisas tipo bandeja para evitar la pérdida de pequeñas piezas. Dispone de ruedas giratorias bloqueables y soporte transporte.

 Zware rolwagen met 4 niveaus (zelf monteren). Plateaus met opstaande rand om kleine onderdelen niet kwijt te raken. Met vergrendelbare wielen en hendel.



Laptop and charger storage trolley

TRD-060

H 838, W 350, D 434mm

 Laptop and charger storage trolley. Fitted with lockable castors.

 Ordinateur portable et chargeur. Muni de roulettes avec blocage intégré

 Laptop und Ladewagen. Ausgestattet mit blockierbaren Rollen.

 Carrello per laptop e caricabatterie. Dotato di ruote orientabili.

 Laptop y cargador de carro. Equipado con ruedas giratorias bloqueables.

 Laptop en laderwagen. Voorzien van vergrendelbare wielen.

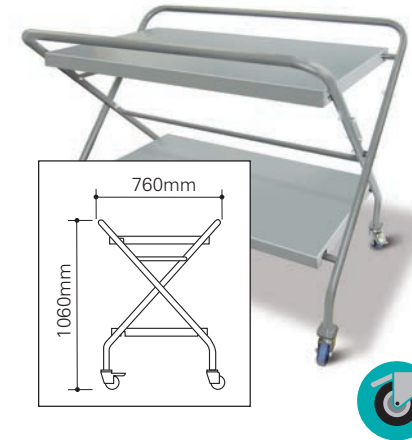



Bumper trolley

TR-004

H 1060, W 1400, D 760mm

 A trolley frame with two shelves, designed for supporting bumpers or similar body panels. Fitted with lockable castors, and can be folded flat for convenient storage.

 Un cadre de chariot à deux étages, conçu pour y poser des pare-chocs ou d'autres panneaux de carrosserie similaires. Équipé de roulettes à blocage intégré et pliable pour un encombrement minimal.

 Ein Transportwagenrahmen mit zwei Einlegeböden, für die Aufnahme von Stoßstangen oder ähnlichen Karosserieteilen entwickelt. Mit blockierbaren Rollen versehen. Kann für die praktische Aufbewahrung flach zusammengeklappt werden.

 Struttura per carrello con due ripiani, creata per supportare paraurti o fiancate di carrozzeria simili. Attrezzata con ruote orientabili bloccabili, può essere piegata per uno stoccaggio più semplice.

 Una estructura de carro con dos bandejas, diseñada para soportar golpes o paneles de cuerpo similar. Contiene ruedas giratorias bloqueables y puede plegarse, para un almacenamiento adecuado.

 Een rolkast frame met twee legplanken, ontworpen voor het dragen van stootbalken of soortgelijke carrosseriebeplating. Uitgerust met vergrendelbare wielen, kan plat worden opgevouwen voor eenvoudige opslag.





Body service trolley

TRS-150

H 1878, W 1500, D 900mm

 Trolley for organising tyres, bumpers and other components.

 Chariot pour organiser les pneus, les pare-chocs et autres composants.

 Transportwagen zum Ordnen von Reifen, Stoßstangen und anderen Bauteilen.

 Carrello per l'organizzazione di pneumatici, paraurti e altri componenti.

 Carro para organizar neumáticos, parachoques y otros componentes.

 Rolkast voor het organiseren van banden, bumpers en andere componenten.

Accessories

- Accessoires
- Zubehör
- Accessori
- Accesorios
- Accessoires

Plinth covers

Revêtements de socles
Abdeckende Fußleisten
Zoccolature
Tapas de zócalo
Plinten

- Plinth covers can be fitted to the front or sides of any cabinet with legs (not available with castors).
- Peuvent être ajustés à l'avant ou sur les côté de n'importe quelle armoire sur pied (non disponibles pour les roulettes).
- Kann bei allen Schränken mit Füßen vorne oder an den Seiten angebracht werden (nicht erhältlich bei Rollschränken).
- Si possono fissare nella parte frontale o laterale di qualsiasi armadio con piedini (non disponibile con ruote orientabili).
- Se puede instalar al frente o a los lados de cualquier armario con patas (no disponible con ruedas giratorias).
- Kunnen aan voor- en zijkant van kasten op poten worden bevestigd (niet geschikt voor kasten op wielen).

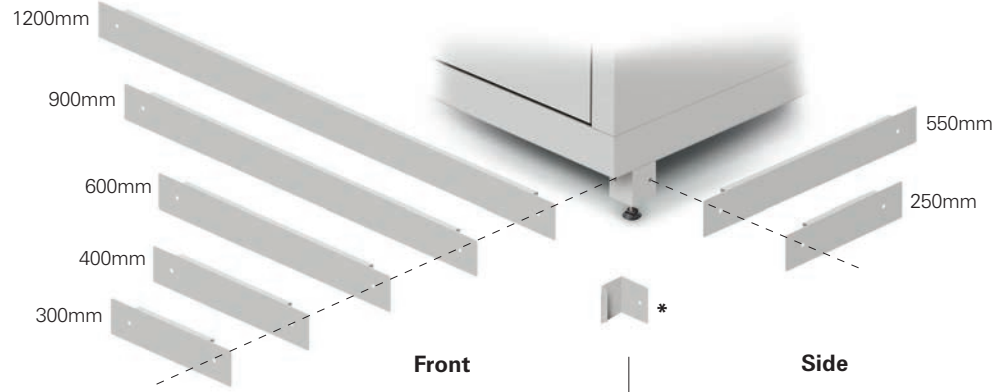
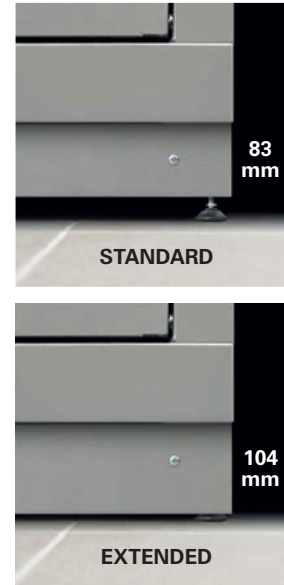

	Front	Side
STANDARD	PLI-120 83 x 1200mm	PLI-055 83 x 550mm
	PLI-092 83 x 900mm	PLI-035 83 x 350mm
	PLI-060 83 x 600mm	PLI-025 83 x 250mm
	PLI-040 83 x 400mm	* PLIC-001 83mm corner
	PLI-030 83 x 300mm	
EXTENDED	PLIE-120 104 x 1200mm	PLIE-055 104 x 550mm
	PLIE-092 104 x 900mm	PLIE-035 104 x 350mm
	PLIE-060 104 x 600mm	PLIE-025 104 x 250mm
	PLIE-040 104 x 400mm	* PLICE-001 104mm corner
	PLIE-030 104 x 300mm	

Sloping panels

Panneaux en pente
Schräge Paneel
Pannelli inclinati
Paneles que se inclinan
Hellende panelen







- Sloping panel – fits to top of cabinet to prevent storage above.
- Panneau en pente - pour s'adapter jusqu'au dessus d'un module pour empêcher la mémoire ci-dessus.
- Schräges Paneel - zur Oberseite eines Schrankes passend, um Lagerung oben zu verhindern.
- Pannello inclinato - adattare alla parte superiore di un armadietto per impedire memoria qui sopra.
- Panel que se inclina - caber a la tapa de una cabina para prevenir almacenaje arriba.
- Hellend paneel - passend op bovenkant kabinet om opslag hierop te verhinderen.

		B Cabinet width / Largeur de Module / Schrankbreite / Larghezza dell'armadietto / Anchura del armario / De breedte van het kabinet		
		600mm	900mm	1200mm
A Cabinet depth Profondeur de Module Schränkentiefe Profondità dell'armadietto Profundidad del armario Kabinets diepte.	300mm	CTS-060	CTS-090	CTS-120
	600mm	CTSL-060	CTSL-090	CTSL-120
	800mm	_____	_____	CTSVSD-120/800
	1030mm	_____	_____	CTSVSD-120

Drawer divider sets

Sets de division des tiroirs
Schubladenteiler-Sätze
Separatori per cassetti
Conjuntos de división para cajones
Scheidingslatten voor lade







-  Drawer divider sets to fill 85mm depth drawers. Contains repositionable dividing slats. Constructed from galvanised steel.
-  Les séparateurs de tiroirs sont conçus pour remplir des tiroirs de 85 mm de profondeur. Contient des séparateurs repositionnables. Construit en acier galvanisé.
-  Schubladenteiler-Satz für eine 85mm Schublade. Enthält repositionierbare Trennwände. Aus verzinktem Stahl gefertigt.
-  Separatori per 85mm cassetti. Contiene divisori riposizionabili. Costruito in acciaio galvanizzato.
-  Los conjuntos de división para cajones de 85 mm de profundidad. Contiene divisores reposicionables. Construido de acero galvanizado.
-  Scheidingslatten voor laden van 85 mm diepte. Niet compatibel met onderkasten. Bevat verplaatsbare verdelers. Gemaakt van gegalvaniseerd staal.



DD-002	600mm RC cabinets
DD-005	900mm RC cabinets
DD-003	1200mm RC cabinets
DDUC-002	600mm UC cabinets
DDUC-091	900mm UC cabinets
DDUC-121	1200mm UC cabinets
DD-062	600mm BU cabinets

Anti-slip matting **AM-001**

Revêtement anti-dérapant incrusté
Antirutschmatte zum Einlegen
Stuoia per cassetto antiscivolo
Revestimiento interior
Antislip inleg

-  Anti-slip drawer inlay matting supplied in 2 rolls of 1.5 metre length, for protecting tools and inside of cabinet.
-  Revêtement anti-dérapant incrusté dans le tiroir fourni en deux rouleaux de 1.5 mètres, pour protéger les outils et l'intérieur du meuble de rangement.
-  Antirutschmatte zum Einlegen in die Schubladen (2 x Rollen 1.5m). Zum Schutz der Werkzeuge und des Schubladeninneren.
-  Stuoia per cassetto antiscivolo fornita in due rotoli da 1.5 metri, per proteggere gli attrezzi e l'interno dell'armadio.
-  Revestimiento interior para cajones antideslizamiento suministrado en dos rollos de 1.5 metros, para proteger las herramientas y el interior del armario.
-  Antislip inleg geleverd in twee rollen van 1.5 meter, voor de bescherming van gereedschap en binnenkant van de kast.



Moulded top trays

Plateau supérieur moulé
Geformte obere Ablage
Vassoio superiore stampato
Bandeja superior moldeada
Gegoten bovenbak

MTT-900

-  Moulded top tray to fit TR-009, UCT-0907, UCT-0906, UCT-0907C & UC-090C.
-  Plateau supérieur moulé pour TR-009, UCT-0907, UCT-0906, UCT-0907C et UC-090C.
-  Geformte obere Ablage für TR-009, UCT-0907, UCT-0906, UCT-0907C und UC-090C.
-  Vassoio superiore stampato per adattarsi a TR-009, UCT-0907, UCT-0906, UCT-0907C e UC-090C.
-  Bandeja superior moldeada para adaptarse a TR-009, UCT-0907, UCT-0906, UCT-0907C y UC-090C.
-  Gegoten bovenbak voor TR-009, UCT-0907, UCT-0906, UCT-0907C & UC-090C.



MTT-600

-  Moulded top tray to fit TR-060, UCT-0607, UCT-0606, UCT-0607C & UC-060C.
-  Plateau supérieur moulé pour TR-060, UCT-0607, UCT-0606, UCT-0607C et UC-060C.
-  Geformte obere Ablage für TR-060, UCT-0607, UCT-0606, UCT-0607C und UC-060C.
-  Vassoio superiore stampato per adattarsi a TR-060, UCT-0607, UCT-0606, UCT-0607C e UC-060C.
-  Bandeja superior moldeada para adaptarse a TR-060, UCT-0607, UCT-0606, UCT-0607C y UC-060C.
-  Gegoten bovenbak voor TR-060, UCT-0607, UCT-0606, UCT-0607C & UC-060C.



Additional shelves

Étagères supplémentaires
Zusätzliche Regale
Mensole supplementari
Estantes adicionales
Extra legplanken



	Suitable cabinets Modules appropriés Verwendbare Schränke Armadietti adatti Armarios convenientes Geschikte kabinetten
	D 600mm
SHC-030	W 300mm, BU
SHC-060	W 600mm, BU/RS/CU/CUES
SHC-061	COSHH-014/COSHH-014L
SHC-090	W 900mm, BU/RS/CU/CUES
SHR-090	W 900mm, RSR
SHC-091	COSHH-092
SHC-120	W 1200mm, BU/RS/CU/CUES
SHR-120	W 1200mm, RSR
	D 400mm
SHC-005	CU007/CU007L
	D 300mm
SHC-123	RS030/RS032
SHC-093	RS093

Hanging rails







Rails suspendus
Aufhängeschiene
Binari appendiabiti
Rieles para colgar
Hangende rails



CR-061	600mm CU cabinets
CR-091	900mm RS cabinets
CR-121	1200mm RS cabinets

CRR-090	900mm RSR cabinets
CRR-120	1200mm RSR cabinets

Additional Pinseal on shelves

-  Pinseal – 3mm hard-wearing surface used as standard for cabinets. *Please ask for further details.*
-  Pinseal surface résistante de 3 mm pour étagère. *Contactez-nous pour plus d'information.*
-  Pinseal 3 mm strapazierfähige Oberfläche, für Regal. *Bitte rufen Sie uns bei weiteren Fragen an.*
-  Pinseal superficie resistente all'usura da 3 mm utilizzata per mensola. *Vi invitiamo a contattarci per maggiori informazioni.*
-  Pinseal superficie resistente de 3 mm utilizada para estante. *Póngase en contacto con nosotros para obtener información adicional.*
-  Pinseal 3 mm slijtvast oppervlak voor legplank. *Neem contact met ons op voor meer informatie.*



Worksurface options

Options des surfaces de travail
Optionen für die Arbeitsfläche
Opzioni per banchi di lavoro
Opciones de superficie de trabajo
Opties werkoppervlak

-  Alternative worksurfaces are available to the standard black composite worktops (see below). **Additional options are available – Please call for further details.**
-  D'autres surfaces de travail sont disponibles pour les tablettes en composite noir standard (Voir ci-dessous). **Des options supplémentaires sont disponibles - Veuillez appeler pour plus de détails.**
-  Alternative Arbeitsflächen sind für die standardmäßigen schwarzen Arbeitsauflagen aus Verbundwerkstoff erhältlich (Siehe unten). **Zusätzliche Optionen sind verfügbar - Bitte rufen Sie für weitere Details.**
-  Sono disponibili banchi di lavoro alternative ai top a composizione mista neri standard (Mostrato sotto). **Sono disponibili opzioni aggiuntive: si prega di chiamare per ulteriori dettagli.**
-  Se dispone de otras alternativas para las superficies de trabajo compuestas negras estándar (Mostrado a continuación). **Hay opciones adicionales disponibles. Llame para obtener más detalles.**
-  Andere werkoppervlakken zijn leverbaar voor het standaard zwarte composiet werkblad (Hieronder weergegeven). **Extra opties zijn beschikbaar - bel voor meer informatie.**

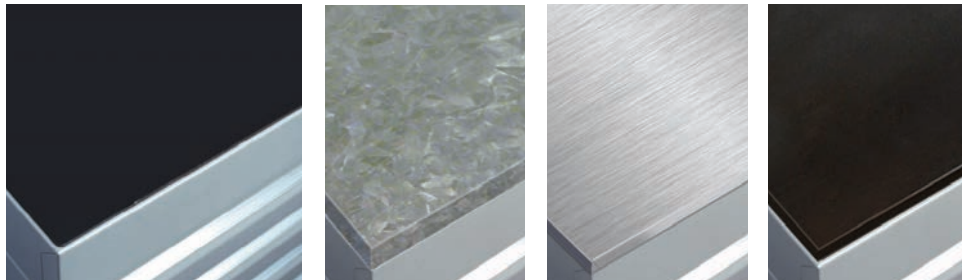

Pinseal – 3mm hard-wearing surface used as standard for cabinets

Pinseal - surface résistante de 3 mm utilisée en standard pour les armoires

Pinseal - 3 mm strapazierfähige Oberfläche, die standardmäßig für Schränke verwendet wird

Pinseal: superficie resistente all'usura da 3 mm utilizzata di serie per gli armadi

Pinseal: superficie resistente de 3 mm utilizada como estándar para gabinetes

Pinseal - 3 mm slijtvast oppervlak dat standaard wordt gebruikt voor kasten

Galvanised steel top (12mm - 40mm)

Surface en acier galvanisé (12 mm - 40 mm)

Oberseite aus verzinktem Stahl (12 mm - 40 mm)

Top in acciaio galvanizzato (12mm - 40 mm)

Parte superior de acero galvanizado (12mm - 40 mm)

Gegalvaniseerd stalen werkblad (12mm - 40 mm)

Stainless steel top (12mm - 40mm)

Surface en acier inoxydable (12 mm - 40 mm)

Arbeitsauflage aus Edelstahl (12 mm - 40 mm)

Top di acciaio inossidabile (12 mm - 40 mm)

Parte superior de acero inoxidable (12 mm - 40 mm)

Roestvrij staal werkoppervlak (12 mm - 40 mm)

12mm Compact resin top
Dessus 12mm en résine compact

12mm kompakte Harzoberfläche







Top in resina compatta da 12mm

Parte superior de resina compacta de 12mm

12mm compact harswerkblad

Key options

Options de verrouillage
Schlüsseloptionen
Opzioni chiave
Opciones de claves
Toetsopties

-  Different lock number per cabinet (keyed to differ), one lock number per workstation (keyed per suite) or all locks the same number (keyed alike).
-  Différents codes de verrouillage par meuble de rangement (verrouillage distinctif), un code de verrouillage par poste de travail (nombres consécutifs) ou un seul code pour toutes les serrures (verrouillage identique).
-  Jeder Schrank hat eine andere Schlossnummer (keyed to differ), eine Schlossnummer pro Arbeitsplatz (keyed per suite) oder alle Schlösser haben die gleiche Nummer (keyed alike).
-  Differente numero di serratura per armadio (con chiave diversa), un numero di serratura per banco di lavoro (chiave unica) o tutte le serrature con lo stesso numero (chiave uguale).
-  Diferentes números de cierre por armario (calculados para variar), un número de cierre por puesto de trabajo (calculados por sucesión) o todos los cierres tienen el mismo número (el mismo código).
-  Verschillende slotnummers per kast (individuele versleuteling), één slotnummer per werkstation (per reeks) of alle sloten met hetzelfde nummer (identieke versleuteling).



'Keyed alike'
'verrouillage identique'
'chiave uguale'
'el mismo código'
'identieke versleuteling'



'Keyed per suite'
'nombres consécutifs'
'chiave unica'
'calculados por sucesión'
'per reeks'





'Keyed to differ'
'verrouillage distinctif'
'con chiave diversa'
'calculados para variar'
'individuele versleuteling'

Standard configuration for tool cabinets
La configuration standard pour armoires à outils
Standardkonfiguration für Werkzeugschränke
Configurazione standard per armadi portautensili
La configuración estándar para armarios de herramientas
Standaard configuratie voor gereedschapskasten

Capping sections and side infill panels

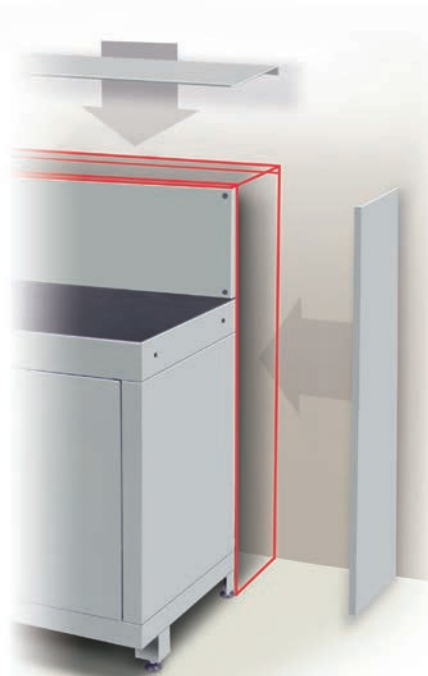
Sections de recouvrement et panneaux d'obturation latérale
 Abdeckabschnitte und Seitenpaneele zur Ausfachung
 Sezioni di rivestimento metallico e pannelli di tamponamento laterali
 Secciones de recubrimiento y paneles laterales de relleno
 Afsluitings-secties en zijdelings invoegbare panelen



 Capping sections and side infill panels are designed to cover spaces between the cabinets and the wall, helping to prevent any workshop rubbish dropping behind the installation. These products are custom-built for each project.

Please call for further details.

 Les sections de recouvrement et les panneaux d'obturation latérale sont conçus pour masquer l'espace entre les armoires et le mur et contribuent à éviter que des déchets de l'atelier tombent derrière l'installation. Ces articles sont fabriqués sur mesure pour chaque projet.

Veillez appeler pour plus de détails.

 Abdeckabschnitte und Seitenpaneele zur Ausfachung wurden dafür entwickelt, Lücken zwischen den Schränken und der Wand auszufüllen, um zu vermeiden, dass Werkstattabfall hinter die Schränke fällt. Diese Artikel werden für jedes Projekt auf Kundenwunsch angefertigt.

Bitte rufen Sie für weitere Details.

 Le sezioni di rivestimento metallico e i pannelli di tamponamento laterali sono stati creati per coprire gli spazi tra gli armadi e il muro, aiutando a prevenire la caduta di residui dell'officina dietro l'impianto. Questi prodotti sono personalizzati a seconda del progetto.

Si prega di chiamare per ulteriori dettagli.

 Las secciones de recubrimiento y los paneles laterales de relleno están diseñados para cubrir espacios entre los armarios y el muro, ayudando de esta manera a prevenir la caída de todo residuo del taller detrás de la instalación. Estos productos son fabricados especialmente para cada proyecto.

Llame para obtener más detalles.

 Afsluitings-secties en zijdelings invoegbare panelen zijn ontworpen om ruimtes tussen de kasten en de muur op te vullen, en zorgen ervoor dat afval van de werkplaats niet achter de installatie valt. Deze producten worden voor ieder project op maat gemaakt.

Bel voor meer informatie.

Rear cover system

Système de capot arrière
 Hinteres Abdeckungssystem
 Rivestimenti posteriori
 Sistema de cubierta trasera
 Afdeksysteem voor achterzijde

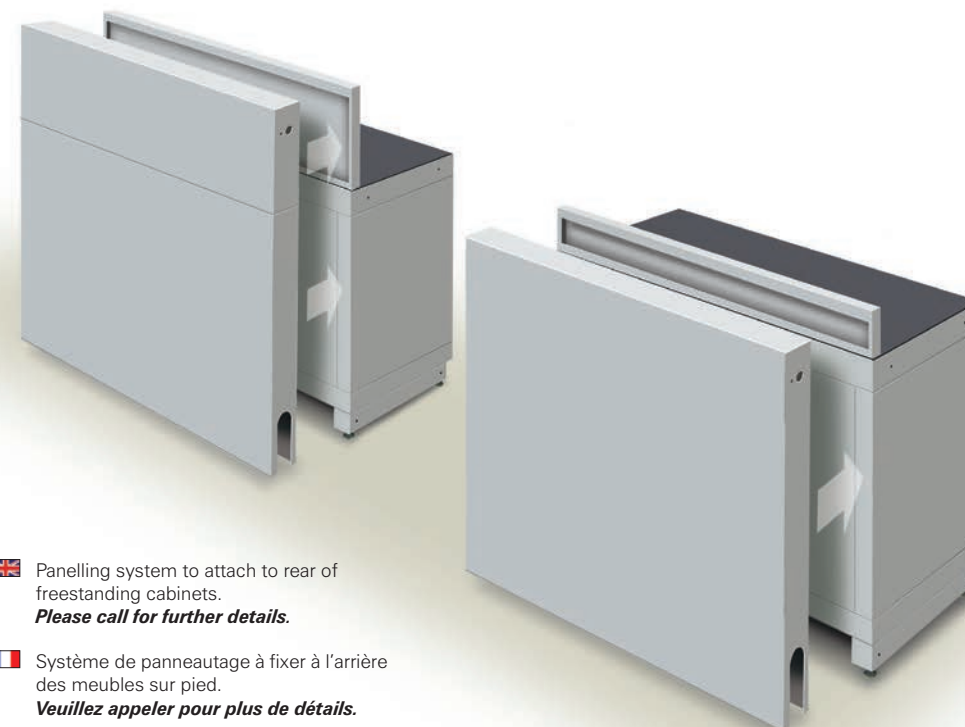

 Panelling system to attach to rear of freestanding cabinets.

Please call for further details.

 Système de panneautage à fixer à l'arrière des meubles sur pied.

Veillez appeler pour plus de détails.

 Paneel-System zur Befestigung an der Rückseite frei-stehender Schränke.

Bitte rufen Sie für weitere Details.

 Sistema di pannelli da montare sulla parte posteriore degli armadi autoreggenti.

Si prega di chiamare per ulteriori dettagli.

 Sistema de paneles para fijarlo a la parte trasera de armarios independientes.

Llame para obtener más detalles.

 Paneelsysteem voor bevestiging aan de achterzijde van vrijstaande kasten.

Bel voor meer informatie.

Floor options

Options de plancher
Bodenoptionen
Opzioni di pavimenti
Opciones de piso
Vloer opties





-  Optional design feature: Raised floor under cabinets (with adjustable feet removed)
Please call for further details.
-  Accessoires optionnels : Base surélevée sous les meubles (pieds réglables enlevés)
Veillez appeler pour plus de détails.
-  Optionales Design-Merkmal: Angehobener Boden unter den Schränken (einstellbare Füße abgenommen)
Bitte rufen Sie uns für weitere Details an.
-  Caratteristica opzionale: Pavimento sopraelevato sotto gli armadi (con piedini regolabili rimossi)
Si prega di chiamare per ulteriori dettagli.
-  Característica de diseño opcional: suelo elevado debajo de los armarios (con patas ajustables retiradas)
Llame para obtener más detalles.
-  Optioneel designkenmerk: Verhoogde vloer onder kasten (met verwijderde instelbare poten)
Bel voor meer informatie.

PVC interlocking floor tiles

Dalles PVC emboîtables
Verzahnte PVC-Bodenplatten
Piastrille in PVC ad incastro
Baldosas encastrables de PVC
Vertande PVC-vloertegels

 PVC floor tiles have become an increasingly popular choice in the workshop because they are easy to fit and require no adhesive, so large areas can be covered quickly with minimal disruption. PVC floor tiles form a great thermal, noise and dust barrier and available with raised studs or a textured finish, and with an anti-static formula. Please ask for further details.

 Les dalles PVC se sont progressivement imposées comme revêtement de sol d'atelier grâce à leur facilité de pose sans colle permettant de couvrir rapidement de grandes surfaces ce qui réduit au minimum la durée d'indisponibilité des locaux. Les dalles PVC créent une barrière efficace contre la chaleur, le bruit et la poussière. Disponibles avec pastilles antidérapantes ou surface texturée et avec formule antistatique. Contactez-nous pour plus d'information.

 PVC-Bodenplatten werden immer mehr zum bevorzugten Bodenbelag in der Werkstatt; sie ermöglichen ein einfaches kleberfreies Verlegen mit minimaler Unterbrechung des Betriebs. PVC-Bodenplatten bilden eine hervorragende Thermo-, Lärm- und Staubbarriere mit erhöhten Noppen oder Strukturoberfläche und Antistatikformel. Bitte rufen Sie uns bei weiteren Fragen an.

 Le piastrelle in PVC sono diventate una delle scelte più diffuse nelle officine, in quanto sono facili da installare e non richiedono adesivi. Ciò consente di rivestire grandi superfici rapidamente e con interruzioni minime. Le piastrelle in PVC sono un'eccellente barriera termica, nonché contro rumori e polveri. Inoltre, sono disponibili in una versione con cerchi sollevati o finiture testurizzate e formula anti-statica. Vi invitiamo a contattarci per maggiori informazioni.

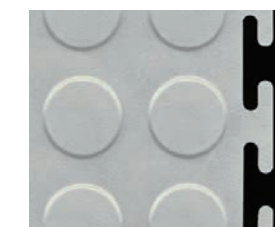

Studded surface
Surface pastillée
Genoppte Oberfläche
Superficie con cerchi
Superficie tachonada
Oppervlak met noppen

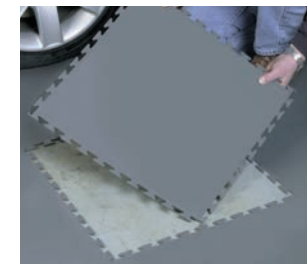

Installed without the need for adhesive
Pose sans colle
Ohne Kleber verlegt
Installabili senza adesivo
Instalación sin necesidad de adhesivo
Verlegging zonder verlijming

 Las baldosas de PVC se han convertido en una opción cada vez más utilizada en talleres ya que resultan fáciles de instalar sin necesidad de adhesivo, de modo que es posible cubrir grandes áreas de forma rápida y con una interrupción mínima del trabajo. Las baldosas de PVC forman una excelente barrera térmica, sonora y antipolvo y están disponibles con tachones elevados o un acabado rugoso, además de con una fórmula antiestática. Póngase en contacto con nosotros para obtener información adicional.

 PVC-vloertegels worden steeds populairder als vloerbedekking in werkplaatsen. Ze zijn gemakkelijk zonder verlijming te leggen waardoor grote oppervlakken snel en met een minimale werkonderbreking kunnen worden bedekt. PVC-vloertegels zorgen voor een uitstekende thermische, lawaai- en stofbarrière en zijn verkrijgbaar met verhoogde noppen of structuuroppervlak en zijn antistatisch. Neem contact met ons op voor meer informatie.



Textured surface
Surface texturée
Strukturoberfläche
Superficie testurizzata
Superficie rugosa
Structuuroppervlak

Quality tools

Outils haut de gamme
Qualitätswerkzeug
Utensili di qualità
Herramientas de calidad
Hoogwaardig Gereedschap



🇬🇧 Dura offer sets of professional quality tools in custom cut control foam to fit Dura tool storage cabinets. The set contains everything required by technicians for modern workshop servicing and are polished chrome vanadium that meet strict ANSI quality standards, covered with a tool lifetime warranty. Dura can also organise tool sets to corporate standards. **Please ask for further details.**

🇫🇷 Dura propose des jeux d'outils professionnels de qualité dans de la mousse découpée sur mesure pour se loger dans les meubles de rangement des outils Dura. Le jeu contient tout ce dont les mécaniciens ont besoin dans un atelier moderne et les outils sont polis au chrome-vanadium, conforme aux strictes normes de qualité de l'ANSI (American National Standards Institute), et couverts par une garantie à vie. Dura peut également composer des jeux d'outils aux normes de l'entreprise.

Merci de nous contacter pour de plus amples détails.

🇩🇪 Dura bietet Werkzeugsätze mit Profiqualität in nach Kundenwunsch geschnittenem Werkzeugkontrollschaumstoff, die in die Werkzeugschränke von Dura passen. Der Satz enthält alles, was Techniker für die moderne Werkstattdienstleistung brauchen. Die Werkzeuge bestehen aus poliertem Chrom-Vanadium-Stahl, der den strengen ANSI Qualitätsnormen entspricht, und haben eine lebenslange Garantie. Dura kann ebenfalls Werkzeugsätze nach Firmennormen zusammenstellen.

Bitte fragen Sie uns für weitere Details.

🇮🇹 Dura offre set di utensili di qualità professionali in gommapiuma per il bloccaggio tagliata su misura adattata agli armadi di stoccaggio degli utensili Dura. Il set contiene tutto il necessario per i tecnici in un'officina moderna e sono lucidati al cromo-vanadio per soddisfare i rigidi standard di qualità ANSI, coperti da una garanzia a vita sugli utensili. Dura può anche creare set di utensili in base agli standard aziendali.

Chiedere per ulteriori dettagli.

🇪🇸 Conjuntos Dura de herramientas de calidad profesional al interior de espuma de control de corte personalizado para instalar armarios de almacenamiento de herramientas Dura. El conjunto contiene todo lo requerido para los técnicos de servicio de talleres modernos y cuenta con vanadio de cromo pulido, conforme con las exigentes normas de calidad ANSI, cubierto por una garantía de herramientas sin límite en el tiempo. Dura puede igualmente organizar conjuntos de herramientas adecuados a normas corporativas.

Solicite información para mayores detalles.

🇳🇱 Dura biedt sets professioneel hoogwaardig gereedschap in op maat gemaakte schuimrubberen inlay voor de Dura kasten, voor het opslaan van gereedschap. De set bevat alle benodigdheden voor technici voor het leveren van moderne werkplaats dienstverlening, zijn chroom- vanadium gepolijst, en voldoen aan de strenge ANSI kwaliteitsnormen. Het wordt geleverd met een levenslange garantie op het gereedschap. Dura kan eveneens gereedschapssets leveren die voldoen aan bedrijfsnormen.

Neem contact met ons op voor nadere informatie.

Tool control foam

Mousse de maintien des outils
Werkzeugkontrollschaumstoff
Gommapiuma per il bloccaggio degli attrezzi
Espuma de control de herramientas
Schuim voor gereedschapbescherming



🇬🇧 Custom-cut tool control foam can be provided for cabinet drawers. These are available in a range of colours and supplied with etched corporate logos, product numbers or inlaid with identity tags.

🇫🇷 Une mousse sur mesure pour les outils peut être fournie pour les tiroirs du meuble de rangement. Elle est disponible dans divers coloris et fournie avec les logos de l'entreprise, les numéros de produit ou avec des étiquettes d'identification intégrées.

🇩🇪 Nach Kundenwunsch geschnittener Werkzeugkontrollschaumstoff kann für die Schrankschubladen geliefert werden. Sie sind in einer Palette von Farben sowie mit zuvor mitgeteilten Firmenlogos, Produktnummern oder mit Kennzeichen unterlegt erhältlich.

🇮🇹 Per i cassetti degli armadi possiamo fornire gommapiuma per il bloccaggio degli attrezzi tagliata su misura. È disponibile con un'ampia gamma di colori e loghi aziendali da voi forniti, codici o cartellini.

🇪🇸 Se puede suministrar espuma de control de herramientas con recorte personalizado para los cajones de los armarios. Están disponibles en una gama de colores y se suministran con los logotipos de la marca, números de productos o con marcas de identificación.

🇳🇱 Op maat gemaakt schuim voor gereedschap mogelijk voor kastladen. Beschikbaar in verschillende kleuren met bedrijfslogo's, productnummers of ingelegd met identificatielabels.

ServicePod™





🇬🇧 The ServicePod™

The ServicePod™ represents an integrated 'all-in-one' solution with facilities for oil/air/water reels, computer and tool storage, wastebin and glove/towel dispenser in one single 2 metre unit.

The design integrates electrical and communications outlets as well as a facility for the optional locking tool storage cabinet that will also house a monitor.

Planning is simple and installation is minimal making the ServicePod ideal not just for new workshops but for enhancing your existing workshop and it's the perfect solution for service reception or rapid fit bays.

🇫🇷 ServicePod™

ServicePod™ est une solution intégrée tout-en-un permettant d'intégrer des enrouleurs de tuyaux d'air comprimé/huile/eau, un poste informatique, le rangement d'outils, une poubelle et un distributeur de gants/papier d'essuyage, le tout dans un meuble de 2 m de longueur.

L'ensemble comprend des prises électriques et de communication ainsi que l'emplacement pour un meuble verrouillable optionnel de rangement d'outils avec emplacement pour un moniteur.

Planification simple et installation minimale font de ServicePod l'équipement idéal, non seulement pour installations neuves mais également pour améliorer les ateliers déjà existants, la solution parfaite pour la réception du service après-vente et les postes d'installation rapide.

🇩🇪 Das ServicePod™

Das ServicePod™ ist eine integrierte 'All-in-One'-Lösung für Öl/Luft/Wasser-Aufroller, Aufbewahrung von Computer und Werkzeug, Abfallbehälter und Handschuh- und Handtuchspender in einer einzigen 2 Meter breiten Einheit.

Das Design integriert Elektrik- und Kommunikationsausgänge sowie die Möglichkeit zum Abschließen des Werkzeugschranks, der auch einen Monitor enthält.

Die Planung ist einfach und die Installation minimal; somit eignet sich das ServicePod ideal nicht nur für neue Werkstätten, sondern auch als Erweiterung bestehender Werkstätten - die perfekte Lösung für den Serviceempfang oder Blitzmontagebuchten.

🇮🇹 ServicePod™

ServicePod™ è una soluzione completa ed integrata dotata di strutture per bobine per olio, aria e acqua, stoccaggio attrezzi e computer, bidone dei rifiuti e dispenser per salviette e guanti, il tutto in un'unica unità di 2 metri.

Il prodotto integra uscite di comunicazione e prese elettriche, nonché una struttura per un armadio opzionale chiudibile a chiave per lo stoccaggio di attrezzi, in grado di ospitare un monitor.

La progettazione è semplice e richiede lavori di installazione minimi, pertanto il ServicePod è l'ideale per le nuove officine, ma anche per migliorare le strutture esistenti. Inoltre è una soluzione ideale per servizi di accoglienza o piattaforme di assistenza rapida.

🇪🇸 ServicePod™

ServicePod™ representa una solución «todo en uno» integrada con elementos para carretes de aceite/aire/agua, ordenador y almacenamiento de herramientas, recipiente de basura y dispensador de guantes/toallitas en una única unidad de 2 metros.

El diseño integra tomas eléctricas y de comunicaciones, así como un espacio para el armario de almacenamiento de herramientas de bloqueo opcional, que aloja también un monitor.

La planificación es sencilla y la instalación mínima, lo que hace de ServicePod la solución ideal para talleres nuevos y para mejorar talleres existentes, y la opción perfecta para áreas de servicio o de servicio rápido.

🇳🇱 De ServicePod™

De ServicePod™ is een geïntegreerde 'alles-in-een'-oplossing voor olie/lucht/water-rollen, de opberging van computer en gereedschap, afvallemmer en automaat voor handschoenen en handdoeken in één enkele 2 meter brede eenheid.

Het design integreert elektrische en communicatie-uitgangen alsmede een mogelijkheid om de gereedschapskast af te sluiten die ook een monitor bevat.

De planning is eenvoudig en de installatie minimaal; zodoende is de ServicePod niet alleen ideaal voor nieuwe werkplaatsen, maar ook voor de uitbreiding van uw bestaande werkplaats. Het is de perfecte oplossing voor de servicereceptie of snelmontageplaatsen.

**Drawer external depths**

Hauteur du tiroir, externe
Schubladenhöhe - außen
Altezza cassetto - esterna
Altura del cajón - externa
Hoogte lade - buitenkant

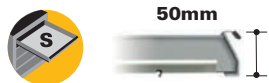

50mm



85mm



180mm

Total capacity
Capacité totale
Gesamtkapazität
Capacità totale
La capacidad total
Totale capaciteit



* Hose ends and back supports protrude 50mm behind rear of cabinet. Allow additional space for connections.

* Les embouts de tuyaux et les supports arrière dépassent sur 50 mm à l'arrière du meuble. Prévoir un espace supplémentaire pour les connexions.

* Schlauchenden und rückseitige Stützen ragen 50mm über die Rückseite des Schrankes hinaus. Zusätzlicher Abstand für die Anschlüsse erforderlich.

* Le estremità dei flessibili e i supporti posteriori sporgono di 50 mm sul retro dell'armadio. Considerare dello spazio aggiuntivo per le connessioni.

* Los extremos de manguera y los soportes traseros sobresalen 50 mm por detrás de la parte trasera del armario. Deje espacio adicional para las conexiones.

* Slangeinden en steunen aan de achterzijde steken 50 mm uit aan de achterzijde van de kast. Inachtneming van extra afstand is nodig voor de aansluitingen.

Product features include:

- A** Facilities for computer screen and keyboard
- B** Square peg panels for tool storage
- C** Power and communication panel
- D** Heavy-duty composite worksurface
- E** Facilities for fluid or air hoses
- F** Glove and towel dispenser
- G** Lockable computer cupboard
- H** Facilities for tool storage in control foam
- I** Wastebin drawer with removable bin
- J** Removable drip trays

Les caractéristiques du produit comprennent:

- A** Emplacement pour écran et clavier d'ordinateur
- B** Panneau perforé pour le rangement des outils
- C** Panneau de prises électriques et de communication
- D** Plan de travail en matériau composite lourd
- E** Emplacement pour tuyaux de fluides ou d'air comprimé
- F** Distributeur de gants/papier d'essuyage
- G** Logement verrouillable pour unité centrale
- H** Emplacement de rangement d'outils dans des formes en mousse
- I** Tiroir à déchet avec bac amovible
- J** Cuvettes d'égouttage amovibles

Die Produkteigenschaften umfassen:

- A** Einrichtungen für Computerbildschirm und Tastatur
- B** Quadratische Lochplatte für die Werkzeugaufbewahrung
- C** Strom- und Kommunikationsplatte
- D** Robuste Arbeitsoberfläche aus Verbundwerkstoff
- E** Einrichtungen für Flüssigkeits- und Luftschläuche
- F** Handschuh- und Handtuchspender
- G** Abschließbarer Computerschrank
- H** Einrichtungen zur Werkzeugaufbewahrung in Kontrollschaumstoff
- I** Fach für herausnehmbaren Abfallbehälter
- J** Abnehmbare Auffangwanne

Le caratteristiche del prodotto comprendono:

- A** Strutture per schermo del computer e tastiera
- B** Pannelli con fori quadrati per lo stoccaggio di attrezzi
- C** Pannello elettrico e di comunicazione
- D** Superficie di lavoro resistente in composito
- E** Impianti per flessibili aria e fluidi
- F** Dispenser di guanti e salviette
- G** Armadio per computer chiudibile a chiave
- H** Strutture in gommapiuma per lo stoccaggio e il blocco di attrezzi
- I** Cassetto con bidone dei rifiuti rimovibile
- J** Sgocciolatoio rimovibili

El producto tiene las características siguientes:

- A** Espacio para pantalla y teclado de ordenador
- B** Paneles perforados cuadrados para almacenamiento de herramientas
- C** Panel de alimentación y comunicaciones
- D** Superficie de trabajo robusta de material compuesto
- E** Espacio para mangueras de líquido o de aire
- F** Dispensador de guantes y toallitas
- G** Espacio para ordenador con cerradura
- H** Espacio de almacenamiento de herramientas en espuma de control
- I** Cajón con recipiente de basura extraíble
- J** Bandejas de goteo extraíbles

Technische kenmerken:

- A** Voorzieningen voor computerscherm en toetsenbord
- B** Panelen met vierkante perforaties voor opslag van gereedschap
- C** Stroom- en communicatiepaneel
- D** Uitgerust met robuust composietwerkoppervlak
- E** Voorzieningen voor vloeistof- of luchtslangen
- F** Handschoen- en handdoekautomaat
- G** Afsluitbare computerkast
- H** Voorzieningen voor gereedschapopslag in schuimrubberen inlays
- I** Lade met uitneembare afvalmermer
- J** Afneembare lekbakken





POD-020

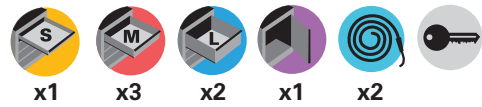

POD-021

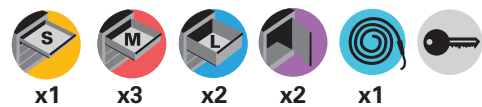

Double-skinned lockable doors.
Portes verrouillables doublées.
Doppelwandige, verschließbare Türen.
Ante chiudibili a chiave a rivestimento doppio strato.
Puertas doble cuerpo cerradas con llave.
Dubbelzijdige afsluitbare deuren.

Maximum number of reels (Reels not included)
Nombre d'enroulements maximal (Enrouleurs pas inclus)
Maximale Anzahl an Aufrollern (Aufroller nicht eingeschlossen)
Numero massimo di bobine (Le bobine non sono incluse)
Cantidad máxima de carretes (Los carretes no son incluidos)
Maximum aantal rollen (Rollen niet inbegrepen)



POD-022

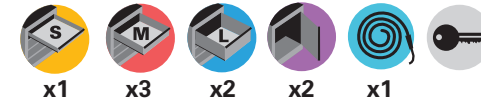

POD-023

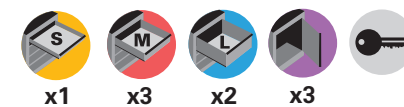

Oil reel and adaptor PODR-001

Enrouleur de tuyau d'huile et adaptateur
Öl-Aufroller und Adapter
Adattatore e bobina per olio
Carrete de aceite y adaptador
Olieroel en adapter







Air/water reel and adaptor PODR-002

Enrouleur de tuyaux d'eau/air comprimé et adaptateur
Luft/Wasser-Aufroller und Adapter
Adattatore e bobina per aria/acqua
Carrete de aire/agua y adaptador
Lucht/water-rol en adapter



Vertical tool storage cabinet POD-024









-  The ServicePod™ can be supplied with or without the vertical tool storage cabinet. This cabinet is W 1000mm x H 700mm and has double locking doors with internal peg panels
-  ServicePod™ est livrable avec ou sans armoire de rangement vertical d'outils. L'armoire (l 1000 mm × H 700 mm) est équipée de deux portes verrouillables et de panneaux intérieurs perforés.
-  Das ServicePod™ kann mit oder ohne vertikalen Werkzeugschrank geliefert werden. Dieser Schrank misst 1000mm (B) x 700mm (H) und hat abschließbare Doppelflügeltüren mit Lochplatten innen
-  ServicePod™ può essere fornito con o senza armadio verticale per lo stoccaggio degli attrezzi. L'armadio misura 1000 mm x 700 mm (L x A) e dispone di doppie ante chiudibili a chiave e pannelli interni con fori quadrati
-  ServicePod™ puede suministrarse con o sin el armario de almacenamiento de herramientas vertical. Este armario tiene 1000 mm de anchura y 700 mm de altura y cuenta con puertas de doble cierre con paneles perforados internos.
-  De ServicePod™ kan met of zonder de verticale kast voor opslag van gereedschap worden geleverd. De kast meet 1000 mm (B) x 700 mm (H) en heeft afsluitbare dubbele deuren met binnenin geperforeerde panelen



-  Other ServicePod™ designs are available.
Please call for further details.
-  D'autres conceptions ServicePod™ sont disponibles.
Veillez appeler pour plus de détails.
-  Andere ServicePod™ -Designs sind erhältlich.
Bitte rufen Sie für weitere Details.
-  Sono disponibili altri design di ServicePod™.
Si prega di chiamare per ulteriori dettagli.
-  Otros diseños de ServicePod™ están disponibles.
Llame para obtener más detalles.
-  Andere ServicePod™ -ontwerpen zijn beschikbaar.
Bel voor meer informatie.



End back panels POD-029 & POD-030

-  A set of two end back panels can be fitted either side of the vertical tool storage cabinet to provide a continuous back wall when the doors are closed. These panels are fitted with backstraps (POD-030)
-  Il est possible d'installer deux panneaux arrière de part et d'autre de l'armoire de rangement vertical d'outils afin de créer une cloison arrière continue quand les portes de l'armoire sont fermées. Les panneaux sont fixés sur des lattes (POD-030)
-  Ein Set aus zwei End-Rückpaneelen kann an beiden Seiten des vertikalen Werkzeugschranks für eine kontinuierliche Rückwand angebracht werden, wenn die Türen geschlossen sind. Diese Paneele sind mit Backstraps (POD-030) versehen
-  È possibile montare alle estremità dell'armadio verticale per lo stoccaggio di attrezzi un set di due pannelli posteriori, disponendoli su entrambi i lati, in modo da creare una parete posteriore continua quando le ante sono chiuse. I pannelli sono dotati di cinghie posteriori (POD-030)
-  Es posible instalar un juego de dos paneles traseros de extremo en cualquiera de los lados del armario de almacenamiento de herramientas para obtener una pared trasera continua cuando se cierran las puertas. Estos paneles incluyen soportes verticales (backstraps) (POD-030)
-  Een set van twee eindachterpanelen kan aan beide zijden van de verticale gereedschapskast worden gemonteerd voor een doorlopende achterwand als de deuren zijn gesloten. Deze panelen zijn van strips (POD-030) voorzien



Side infill panels SIPSP-150

-  150mm wide side infill panel to provide a continuous cover to a back wall.
-  Panneau latéral de remplissage, largeur 150 mm, pour créer une couverture continue d'appui contre un mur.
-  150 mm breites Seitenpaneel zur Ausfachung für eine durchgehende Rückwandabdeckung.
-  Pannello di tamponamento laterale largo 150 mm per una copertura continua delle pareti posteriori.
-  Panel lateral de relleno de 150 mm de anchura para proporcionar una cubierta continua a una pared trasera.
-  150 mm breed zijdelings invogbaar paneel voor een doorlopende afdekking naar een achterwand.

Wall cladding & modular partition wall systems

Système de revêtement mural & Système mural modulaire
Wandverkleidungssystem & Modulares Wandsystem
Rivestimenti a parete & Sistema a muro modulare
Sistema de revestimiento mural & Sistema de muro modular
Wandbekleidungssystem & Modulair wandsysteem



Wall cladding system

Système de revêtement mural
 Wandverkleidungssystem
 Rivestimenti a parete
 Sistema de revestimiento mural
 Wandbekledingssysteem

UK This panel system has been designed to create wall areas to fit neatly around the cabinet system. The system allows the integration of higher level storage using the square peg panel and louvre systems.



FR Ce système de panneau a été conçu pour créer des surfaces murales qui s'intègrent autour du système d'armoires. Le système utilise des panneaux perforés et des louveres pour l'intégration de rangements en hauteur.

DE Dieses Verkleidungssystem schafft Wandbereiche, die perfekt um das Schranksystem herumpassen. Das System ermöglicht die Integration von mehr Aufbewahrungskapazität mit den quadratischen Lochplatten- und Lüftungssystemen.

IT Questo sistema di pannelli è stato ideato per creare delle pareti che si adattino perfettamente intorno agli armadi. Il sistema consente inoltre l'integrazione di elementi di stoccaggio più alti grazie a dei pannelli con fori quadrati o stecche verticali.

ES Este sistema de paneles se ha diseñado para crear zonas murales que encajen a la perfección alrededor del sistema de armarios. Permite integrar un almacenamiento de alto nivel utilizando los sistemas de panel perforado cuadrado y de persiana.

NL Dit paneelsysteem is ontworpen om wandsecties te creëren die perfect rondom het kaststelsel passen. Het systeem maakt de integratie mogelijk van meer opslagcapaciteit door gebruikmaking van systemen met vierkant geperforeerde panelen en lamellen.

			
A Upper Panels Panneaux supérieurs Obere Paneele Pannelli superiori Paneles superiores Bovenpanelen	W 300mm W 600mm W 900mm W 1200mm W 1500mm	CLA-031 CLA-061 CLA-091 CLA-121 CLA-151	CLA-031S CLA-061S CLA-091S CLA-121S CLA-151S
B Lower Panels Panneaux inférieurs Untere Paneele Pannelli inferiori Paneles inferiores Onderpanelen	W 300mm W 600mm W 900mm W 1200mm W 1500mm	CLA-030 CLA-060 CLA-090 CLA-120 CLA-150	CLA-030S CLA-060S CLA-090S CLA-120S CLA-150S





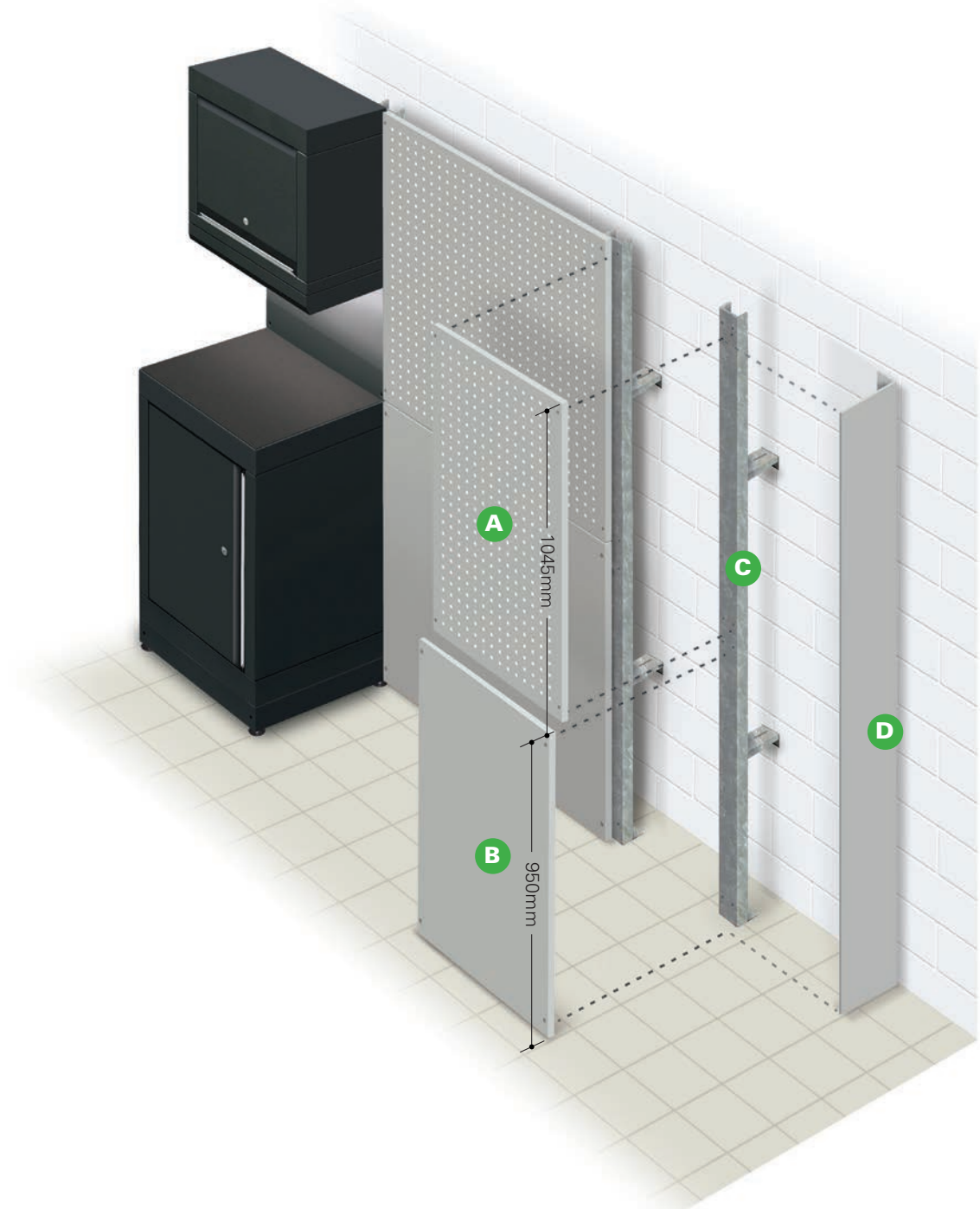

C **Backstrap Posts**
 Poteaux de sanglage
 Backstrap-Pfosten
 Cinghie posteriori
 Postes con soportes verticales (backstraps)
 Stripstijlen
H 2000mm CLA-001

D **End covers**
 Capot d'extrémité
 Endabdeckungen
 Rivestimenti estremità
 Cubiertas de extremo
 Eindafdekkingen
W 100mm CLAC-100
W 150mm CLAC-150



Modular partition wall system

Système mural modulaire
Modulares Wandsystem
Sistema a muro modulare
Sistema de muro modular
Modulair wandsysteem

-  A modular wall system to compliment the Dura range. Ideal for providing walkways or partitions for bays. *Please call for further details.*
-  Un système mural modulaire pour compléter la gamme Dura. Idéal aménager les couloirs ou cloisonner les vestiaires. *Merci de nous contacter pour de plus amples détails.*
-  Un sistema de muro modular para completar la gama Dura. Ideal para adecuar pasillos o divisiones para bastidores. *Por favor contáctenos si desea más informaciones.*
-  Ein modulares Wandsystem, um die Dura-Palette zu erweitern. Ideal, um Gehwege oder Zwischenräume freizulassen. *Bitte rufen Sie uns für weitere Details an.*
-  Un sistema a muro modulare per completare la gamma Dura. Ideale per fornire passaggi o divisioni per posti macchina. *Chiamare per ulteriori dettagli.*
-  Een modulair wandsysteem als aanvulling op het Dura assortiment. Ideaal voor het aanbrengen van wandelpaden of het maken van scheidingswanden. *Voor meer informatie gelieve contact met ons op te nemen.*

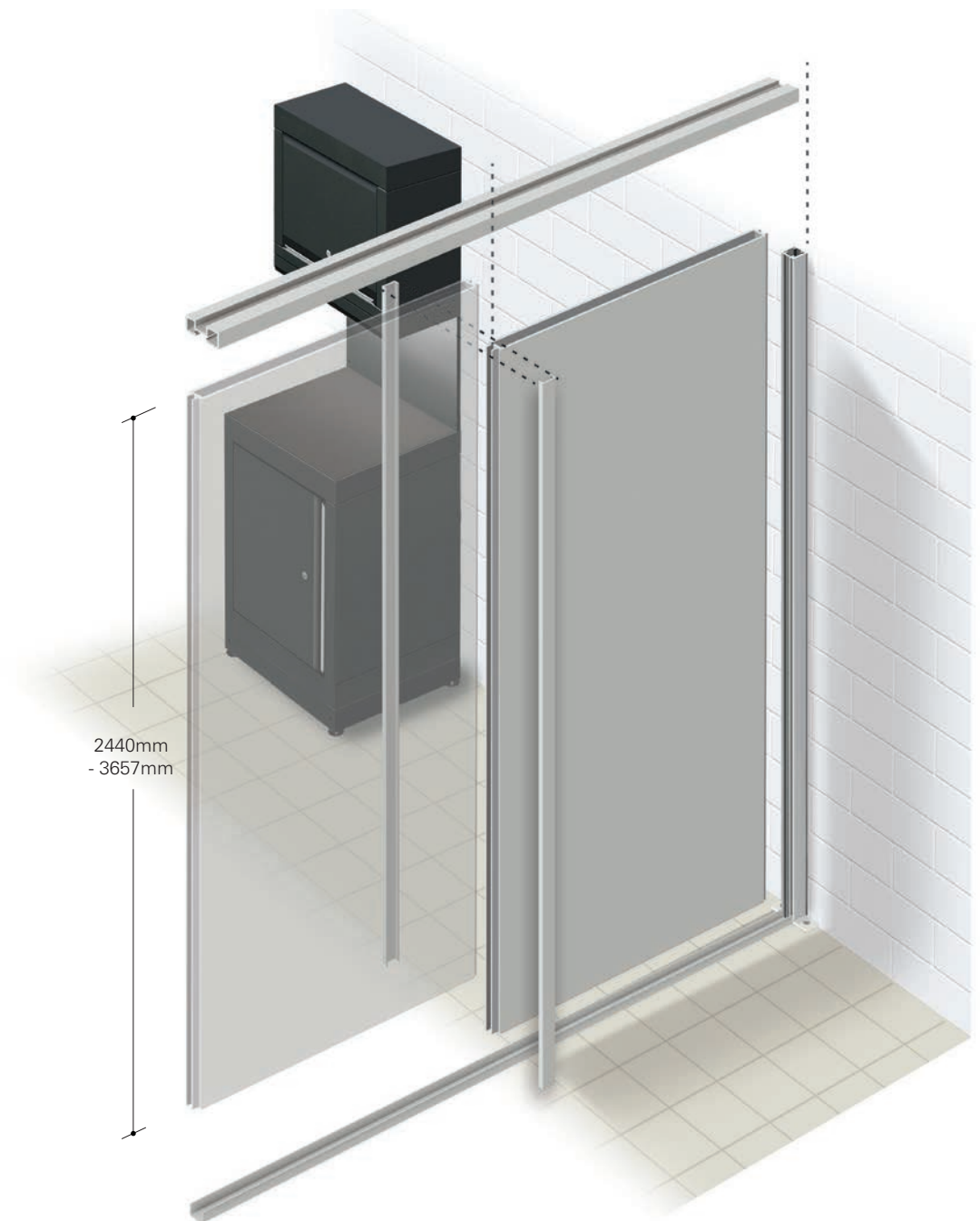

Bespoke Product Service

Service de conception d'articles sur mesure
 Maßgeschneiderter Produktdesignservice
 Servizio di progettazione di prodotti su misura
 Servicio personalizado de diseño de producto
 Product Design Service op Maat



UK Bespoke Product Service

For corporate clients, we offer a full product design consultancy service, from simple adaptation of an existing product to the 'ground up' design of a new product or range of products to meet your exact requirements. This includes design, visualisation, prototyping and manufacture. Please ask for further details.

FR Service de conception d'articles sur mesure

Pour les clients professionnels, nous proposons des services de conseil en conception de produits, de la simple adaptation d'un produit existant à la conception intégrale d'un produit ou d'une gamme de produits répondant exactement à vos besoins. Cette démarche inclut la conception, la visualisation, la réalisation du prototype et la fabrication. Merci de nous contacter pour de plus amples détails.

DE Maßgeschneiderter Produktdesignservice

Für Firmenkunden bieten wir einen umfassenden Produktdesign-Beratungsdienst, von der einfachen Anpassung an ein existierendes Produkt bis zur Entwicklung „von Grund auf“ eines neuen Produkts oder einer neuen Produktpalette, um Ihren Anforderungen ganz genau zu entsprechen. Dies umfasst die Entwicklung, visuelle Darstellung, Prototypenentwicklung und Fertigung. Bitte fragen Sie uns für weitere Details.

IT Servizio di progettazione di prodotti su misura

Per i clienti aziendali, offriamo un servizio completo di consulenza sulla progettazione dei prodotti, dal semplice adattamento di un prodotto esistente alla progettazione 'dall'inizio alla fine' di un nuovo prodotto o gamma di prodotti per soddisfare ogni esigenza. Questo comprende la progettazione, la visualizzazione, la prototipazione e la produzione. Chiedere per ulteriori dettagli.

ES Servicio personalizado de diseño de producto

Para clientes corporativos, ofrecemos un servicio completo de asesoría al diseño, para la adaptación simple de un producto existente al diseño 'desde las etapas iniciales' de un nuevo producto o gama de productos, para satisfacer sus requerimientos específicos. Incluye el diseño, visualización, fabricación de prototipo y fabricación. Solicite información para mayores detalles.

NL Product Design Service op Maat

Wij leveren aan klanten van de organisatie een uitgebreide adviesdienst product design : van de eenvoudige aanpassing van een bestaand product naar het 'vanaf de bodem' ontwerpen van een nieuw productassortiment dat exact aan uw eisen voldoet. Dit omvat ontwerpen, visualisering, prototyping en fabricage. Neem contact met ons op voor nadere informatie.



Product Index

Index de produit
Produktverzeichnis
Indice dei prodotti
Índice de productos
Index van producten

Product Index

Index de produit
Produktverzeichnis
Indice dei prodotti
Índice de productos
Index van producten

PLI-060	138
PLI-092	138
PLI-120	138
PLIC-001	138
PLICE-001	138
PLIE-025	138
PLIE-030	138
PLIE-035	138
PLIE-040	138
PLIE-055	138
PLIE-060	138
PLIE-092	138
PLIE-120	138
POD-020	158
POD-021	158
POD-022	159
POD-023	159
POD-024	160
POD-029	161
POD-030	161
PODR-001	159
PODR-002	159
R	
RC-020C	21
RC-020F	21
RC-040C	13
RC-040F	11
RC-050C	13
RC-050F	11
RC-060C	13
RC-060F	11
RC-070C	13
RC-070F	11
RC-152F	21
RC-182F	21
RC-604C	19
RC-604F	18
RC-605C	19
RC-605F	18

RC-606C	19
RC-606F	18
RC-902C	21
RC-902F	21
RC-904C	17
RC-904F	15
RC-905C	17
RC-905F	15
RC-906C	17
RC-906F	15
RC-907C	17
RC-907F	15
RCB-050F	11
RCB-060F	11
RCB-905F	15
RCB-906F	15
RCD-040F	11
RCD-050F	11
RCD-904F	15
RCD-905F	15
RCH-109	23
RCH-110	23
RCH-111	23
RCH-909	25
RCH-910	25
RCH-911	25
RCT-060C	13
RCT-060F	11
RCT-070C	13
RCT-070F	11
RCT-906C	17
RCT-906F	15
RCT-907C	17
RCT-907F	15
RCTH-111	23
RCTH-911	25
RS-030	65
RS-032	65
RS-060	65
RS-062	65
RS-090	65

RS-092	65
RS-093	65
RSC-092	93
RSH-1230	65
RSH-1260	65
RSH-930	65
RSH-960	65
RSP-063	65
RSP-093	65
RSR-040	67
RSR-050	67
RSR-060	67
RSR-070	67
RSR-904	67
RSR-905	67
RSR-906	67
RSR-907	67
RSS-060	72
RSS-090	72
RSS-099	72
RSS-120	72

S	
SH-004	117
SHC-005	142
SHC-030	142
SHC-060	70 & 142
SHC-061	142
SHC-090	142
SHC-091	142
SHC-093	142
SHC-120	142
SHC-123	142
SHR-090	66 & 142
SHR-120	66 & 142
SIPSP-150	161
SK-001	113
SK-060050	121
SK-060160	113
SK-060300	113
SK-090	113
SK-090050	121
SK-090160	113

SK-090300	113
SK-120	113
SK-120050	121
SK-120160	113
SK-120300	113
SQ-060	114
SQ-090	114
SQ-120	114
SQR-001	115
SQR-002	115
SQR-003	115
SQR-004	115
SQR-005	115
SQR-006	115
SQR-007	115
SQR-008	115
SQR-009	115
SQR-010	115
SQR-011	115
SQR-012	115

T	
TOW-001	129
TR-001	134
TR-004	135
TR-005	133
TR-007	130
TR-009	132
TR-060	132
TR-061	132
TR-120	132
TR-175	133
TRD-060	134
TRS-150	135
TRU-060	123
TRU-090	123
TRU-120	123
TRUE-060	123
TRUE-090	123
TRUE-120	123

U	
UBP-001	113
UBP-090	113

UBP-120	113
UC-0607C	40
UC-060C	40
UC-0907C	39
UC-090C	39
UC-1207C	38
UC-120C	38
UCL-001	109
UCL-002	109
UCL-003	109
UCL-004	109
UCL-005	107
UCL-006	107
UCL-060	109
UCL-090	109
UCL-120	109
UCP-030	109
UCP-060	109
UCP-090	109
UCP-120	109
UCT-0606	40
UCT-0607	40
UCT-0906	39
UCT-0907	39
UCT-1206	38
UCT-1207	38
UKP-001	66 & 123
USH-060	118
USH-090	118
USH-120	118

V	
VIC-001	127
VIC-003	127
VRD-450	92
VSD-030	26
VSD-031	27
VSD-121	45
VSD-128	45
VSDSQR-001	114
VTC-1050	33
VTC-1054	32

W	
WB-001	126
WB-002	126
WB-003	126
WB-007	126
WB-009	126
WB-090	126
WB-092	126
WBBP-850	127
WBBP-900	127
WBBP-950	127
WDU-090	105
WDU-120	105
WPB-002	113
WPB-091	113
WPB-121	113
WU-012	107
WU-030	107
WU-060	98
WU-090	98
WU-120	98
WUE-060	99
WUE-090	99
WUE-120	99
WUFC-090	103
WUFC-120	103
WUIT-060	100
WUIT-090	100
WUIT-120	100
WUTB-060	104
WUTB-090	104
WUTB-120	104
WUTB-121	106
WUTBC-060	104
WUVDT-090	102
WUVDT-120	102
WUVDU-060	101
WUVDU-090	101
WUVDU-120	101
WWB-060	129
WWB-120	129



DURA[®]

*The benchmark in
integrated workshop furniture*

DURA[®]

Dura Limited
St James Road, Brackley
Northants NN13 7XY
tel +44 (0) 1280 706050
fax +44 (0) 1280 700444
email info@dura.co.uk
web www.dura.com/business

*Due to our policy of continuous improvement,
we reserve the right to alter specifications
and prices without prior notice.*